



CATÁLOGO

MISTURADORES	
MONOCOMANDO	4
MONOCOMANDO	5
MONOCOMANDO PRIME	6
MONOCOMANDO COLOR	7
COZINHA	
QUADRA 1167	8
QUADRA 1168	9
COLOR FLEX 1167 1201	10
GOURMET 1167 1168	11
AQUADUO 1167	12
AQUADUO 1168	13
COZINHA LAVATÓRIO	
CLASSIC SLIM - 5/8	14
CLASSIC CLINIC	15
COZINHA	
LUXO 1167	16
LUXO 1168	17
LAVATÓRIO	
LUXO 1198	18
COZINHA	
LUXO SLIM TUBE	19
AUTOMÁTICA	
1197 METAL	19
VÁLVULA MICTÓRIO	19
LINHA PRIME BANHEIRO	
BLACK	20
QUADRA BLACK	21
GOLD	22
QUADRA GOLD	23
ROSE	24
QUADRA ROSE	25
CORTEN	26
QUADRA CORTEN	27
CROMADA	28
QUADRA CROMADA	29
PURIFICADOR DE ÁGUA COLOR FLEX	
2168 METAL	30
2168 METAL - COPO ABS	31
PURIFICADOR DE ÁGUA GOURMET	
2168 METAL	32
2168 METAL - COPO ABS	32
PURIFICADOR DE ÁGUA GOURMET DUO	
2168 METAL	33
2168 METAL - COPO ABS	33
PURIFICADOR DE ÁGUA	
2168 METAL	34
2168 MISTA	34
2168 METAL - COPO ABS	35
BASE	
2168 METAL	35
PURIFICADOR DE ÁGUA AQUADUO	
2167 METAL - COPO ABS	36
PURIFICADOR DE ÁGUA COLOR FLEX	
2167 METAL - COPO ABS	37
PURIFICADOR DE ÁGUA GOURMET	
2167 METAL	38
2167 METAL - COPO ABS	38
VELA PRÓ-SAUDE	39
PURIFICADOR DE ÁGUA GOURMET DUO	
2167 METAL - COPO ABS	39
PURIFICADOR DE ÁGUA	
2167 METAL	40
2167 MISTA	40
2167 METAL - COPO ABS	41
BASE	
2167 METAL	41
PURIFICADOR DE ÁGUA	
2159 METAL	42
PURIFICADOR DE ÁGUA	
2159 METAL - COPO ABS	43

COZINHA	
1167 METAL	44
1167 MISTA	45
1167 GOURMET - 5/8	47
1168 METAL	46
1168 MISTA	47
1168 GOURMET - 5/8	47
1167 METAL BICA BAIXA	48
1168 METAL BICA BAIXA	49
1567 CREE	49
1150 METAL	50
1150 MISTA	50
1158 METAL	51
1158 MISTA	51
1158 METAL C/ AREJADOR	52
1158 MISTA C/ AREJADOR	52
1158 METAL C/ BICO	53
1158 MISTA C/ BICO	53
1159 METAL	54
1159 MISTA	54
1159 METAL C/ AREJADOR	55
1159 MISTA C/ AREJADOR	55
1159 METAL C/ BICO	56
1159 MISTA C/ BICO	56

LAVATÓRIO	
1198 METAL	57
1198 MISTA	57
1194 METAL	58
1194 MISTA	58
1193 METAL	59
1193 MISTA	59

DUCHA HIGIÊNICA	
1739 METAL	60
1739 MISTA	60

DUCHA HIGIÊNICA C/ DESVIADOR	
1740 METAL	61
1740 MISTA	61

DUCHA HIGIÊNICA	
1739 REPOSIÇÃO	62
1740 REPOSIÇÃO	62

MÁQUINA DE LAVAR	
1420 METAL	62
1428 METAL C/ BICO	63
1428 MISTA C/ BICO	63

TANQUE	
1126 METAL	64
1126 MISTA	64

JARDIM	
1128 METAL	64
1130 METAL	65
1130 MISTA	65

REGISTRO DE GAVETA	
1509 1 METAL	66
1509 1.1/2 METAL MISTA	66
1509 1.1/4 METAL	66
1509 BRUTO	66
1509 1/2 METAL MISTA	67
1509 3/4 METAL MISTA	67
1509 BASES	67

REGISTRO DE PRESSÃO	
1400 1/2 METAL MISTA	68
1400 3/4 METAL MISTA	68
1416 1/2 METAL MISTA	69
1416 3/4 METAL MISTA	69
1416 3/4 LUXO METAL	70
1416 BASES	70

KIT SOS COM ACABAMENTO	
METAL	71
MISTO	71
10 X 1	71

ACABAMENTO	
1.1/2	72
3/4	72
3/4 MISTA	72
DOCOL	72

REPARO	
REGISTRO DE PRESSÃO	73
TORNEIRA	73
CABEÇOTES	73

ACESSÓRIOS	
REPOSIÇÃO	74
BICA	74
TUBO DE LIGAÇÃO	75
BRACO CHUVEIRO	75
PROLONGADOR BUCHA	75
PROLONGADOR EXTENSOR	75
PROLONGADOR PROLONGADOR	75
FIXAÇÃO	75
PARAFUSO	76
RALO QUADRADO / REDONDO	76
RALO PRATIC	76
RALO GRELHA	76
ENGATE INOX	76
ENGATE TRANÇADO	76
VÁLVULA	77
BÓJA	77
ELETRICO GRAMPO	77
ELETRICO CONECTOR	77
ELETRICO TERMINAL DE BATERIA	77
PUXADOR REDONDO	78
PUXADOR REDONDO ORIENTE	78
PUXADOR BARRA CHATA	78
PUXADOR BARRA CHATA SLIM	78
BARRA DE APOIO RETA	79
BARRA DE APOIO ESPECIAL	79

KIT PARA BANHEIRO	
STANDARD LUXO CROMADO	80
STANDARD CROMADO	80
JUNIOR CROMADO	80
5 PEÇAS ACRÍLICO TRANSPARENTE	80
5 PEÇAS ACRÍLICO FUMÉ	80
5 PEÇAS ACRÍLICO VERDE	80
CLEAN	81

ACESSÓRIOS PARA BANHEIRO	
PORTA SHAMPOO	81
CHUVEIRO	81

BEBEDOURO	
BEBEDOURO	82
BEBEDOURO	83

LAVABO	
BARCELONA 50	84
BARCELONA 80	84
BARI 45	85
MADRI 50	86
MADRI 80	86
MARANATA 60	87
MARANATA 80	87
REAL 60	88
REAL 80	88
FULL 50 80	89
FULL EDITION 50 80	89
EXPOSITOR	90



Uma empresa brasileira, localizada na cidade de Loanda, Capital das Torneiras, noroeste do estado do Paraná, destaca-se como uma das principais empresas do setor de metais sanitários do país.

Há 25 anos, a **Real Metais** transforma matéria-prima em produtos eficientes, acessíveis e inovadores, atendendo os altos padrões e normas de qualidade.

São técnicos, engenheiros e designers assistindo e analisando cada detalhe desde o desenvolvimento dos projetos - que é um dos diferenciais da marca até a realização de rígidos testes de controle de qualidade e pesquisando tendências e novas tecnologias.

LINHA LUXO

Misturadores MONOCOMANDO



COZINHA
BASE PARA **BANCADA**



2025
MISTURADOR
MONOCOMANDO
26442



2087
MISTURADOR
MONOCOMANDO
25825



2075
MISTURADOR
MONOCOMANDO
29124



2076
MISTURADOR
MONOCOMANDO
BLACK
29123



Misturadores MONOCOMANDO



2071
MISTURADOR
MONOCOMANDO

26440



1262
MISTURADOR
MONOCOMANDO

9006



2073
MISTURADOR
MONOCOMANDO

26439

LAVATÓRIO BASE PARA BANCADA



1878
MISTURADOR
MONOCOMANDO

8988

1870 MISTURADOR MONOCOMANDO QUAD PEQUENO

29126



1875
MISTURADOR
MONOCOMANDO
PEQUENO

29125



Misturadores MONOCOMANDO PRIME



COZINHA
BASE PARA **BANCADA**



2087
MISTURADOR
MONOCOMANDO | **BLACK**

29430

2087
MISTURADOR
MONOCOMANDO | **GOLD**

29431



2087
MISTURADOR
MONOCOMANDO | **ROSE**

29432



Misturadores MONOCOMANDO COLOR



COZINHA BASE PARA BANCADA



2080
MISTURADOR
MONOCOMANDO | **BLACK**

7340

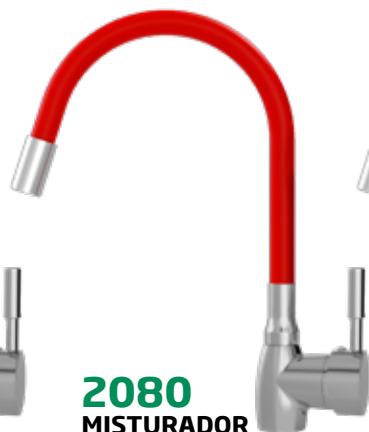

2080
MISTURADOR
MONOCOMANDO | **VERMELHO**

7380

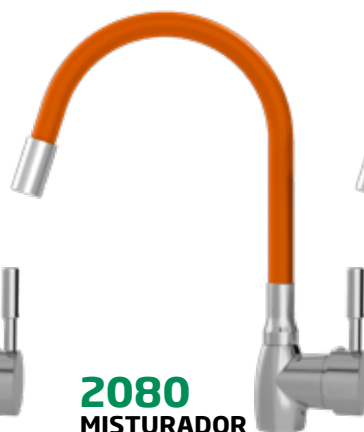

2080
MISTURADOR
MONOCOMANDO | **LARANJA**

15306



2080
MISTURADOR
MONOCOMANDO | **BRANCO**

7381



2080
MISTURADOR DUO
MONOCOMANDO | **BLACK**

15298



2080
MISTURADOR DUO
MONOCOMANDO | **VERMELHO**

15302



2080
MISTURADOR DUO
MONOCOMANDO | **CROMADO**

7383



2080
MISTURADOR GOURMET
MONOCOMANDO | **CROMADO**

7384

Cozinha
QUADRA | 1167



TORNEIRA BICA FLEXÍVEL
BASE PARA PAREDE



	Código	Acab.	Abertura	Material
	27480	C80	1/4 Volta	Metal/Flex Branco
	27481	C80	1/4 Volta	Metal/Flex Laranja
	27478	C80	1/4 Volta	Metal/Flex Preto
	27479	C80	1/4 Volta	Metal/Flex Vermelho
	27476	C80	1/4 Volta	Metal/Flex Duo Preto
	27477	C80	1/4 Volta	Metal/Flex Duo Vermelho
	27475	C80	1/4 Volta	Metal/Gourmet Duo
	27474	C80	1/4 Volta	Metal/Gourmet



Cozinha

QUADRA | 1168



TORNEIRA BICA FLEXÍVEL
BASE PARA **BANCADA**



Código	Acab.	Abertura	Material
27482	C80	1/4 Volta	Metal/Flex Branco
27483	C80	1/4 Volta	Metal/Flex Laranja
27484	C80	1/4 Volta	Metal/Flex Preto
27486	C80	1/4 Volta	Metal/Flex Vermelho
27485	C80	1/4 Volta	Metal/Flex Duo Preto
27487	C80	1/4 Volta	Metal/Flex Duo Vermelho
27489	C80	1/4 Volta	Metal/Gourmet Duo
27488	C80	1/4 Volta	Metal/Gourmet



Cozinha
COLOR FLEX | 1167 | 1201



DICAS DE USO
 E MANUTENÇÃO

TORNEIRA BICA FLEXÍVEL
 BASE PARA PAREDE

BASE PARA BANCADA



Código	Acab.	Abertura	Material
25201	C90	1/4 Volta	Metal/Flex Branco
25202	C90	1/4 Volta	Metal/Flex Laranja
25204	C90	1/4 Volta	Metal/Flex Preto
25199	C90	1/4 Volta	Metal/Flex Vermelho

Código	Acab.	Abertura	Material
25205	C90	1/4 Volta	Metal/Flex Branco
25206	C90	1/4 Volta	Metal/Flex Laranja
25208	C90	1/4 Volta	Metal/Flex Preto
25200	C90	1/4 Volta	Metal/Flex Vermelho

Cozinha
GOURMET | 1167 | 1168



TORNEIRA BICA FLEXÍVEL
BASE PARA PAREDE

BASE PARA BANCADA



Código	Acab.	Abertura	Material
23321	40	1/4 Volta	Metal/Gourmet
23322	50	1/4 Volta	Metal/Gourmet
26274	70	1/4 Volta	Metal/Gourmet
23320	MONOC	1/4 Volta	Metal/Gourmet



Código	Acab.	Abertura	Material
23335	40	1/4 Volta	Metal/Gourmet
23336	50	1/4 Volta	Metal/Gourmet
26275	70	1/4 Volta	Metal/Gourmet
23337	MONOC	1/4 Volta	Metal/Gourmet



Cozinha

AQUADUO | 1167



TORNEIRA BICA FLEXÍVEL BASE PARA PAREDE



Código	Acab.	Abertura	Material
28135	C17	1/4 Volta	Metal/Flex Amarelo
28137	C17	1/4 Volta	Metal/Flex Azul
28138	C17	1/4 Volta	Metal/Flex Branco
28139	C17	1/4 Volta	Metal/Flex Cinza
28145	C17	1/4 Volta	Metal/Flex Laranja
28141	C17	1/4 Volta	Metal/Flex Preto
28146	C17	1/4 Volta	Metal/Flex Rosa
28147	C17	1/4 Volta	Metal/Flex Verde
28140	C17	1/4 Volta	Metal/Flex Vermelho



Código	Acab.	Abertura	Material
16425	C70	1/4 Volta	Metal/Flex Amarelo
7797	C70	1/4 Volta	Metal/Flex Azul
7794	C70	1/4 Volta	Metal/Flex Branco
7740	C70	1/4 Volta	Metal/Flex Cinza
20953	C70	1/4 Volta	Metal/Flex Laranja
7743	C70	1/4 Volta	Metal/Flex Preto
14431	C70	1/4 Volta	Metal/Flex Rosa
8511	C70	1/4 Volta	Metal/Flex Verde
14432	C70	1/4 Volta	Metal/Flex Vermelho



DICAS DE USO
E MANUTENÇÃO



Cozinha

AQUADUO | 1168



TORNEIRA BICA FLEXÍVEL BASE PARA BANCADA



Código	Acab.	Abertura	Material
28128	C17	1/4 Volta	Metal/Flex Amarelo
28130	C17	1/4 Volta	Metal/Flex Azul
28131	C17	1/4 Volta	Metal/Flex Branco
28132	C17	1/4 Volta	Metal/Flex Cinza
28142	C17	1/4 Volta	Metal/Flex Laranja
28134	C17	1/4 Volta	Metal/Flex Preto
28143	C17	1/4 Volta	Metal/Flex Rosa
28144	C17	1/4 Volta	Metal/Flex Verde
28133	C17	1/4 Volta	Metal/Flex Vermelho



Código	Acab.	Abertura	Material
8647	C70	1/4 Volta	Metal/Flex Amarelo
10610	C70	1/4 Volta	Metal/Flex Azul
8649	C70	1/4 Volta	Metal/Flex Branco
8650	C70	1/4 Volta	Metal/Flex Cinza
8648	C70	1/4 Volta	Metal/Flex Laranja
8651	C70	1/4 Volta	Metal/Flex Preto
8652	C70	1/4 Volta	Metal/Flex Rosa
8653	C70	1/4 Volta	Metal/Flex Verde
8654	C70	1/4 Volta	Metal/Flex Vermelho



DICAS DE USO
E MANUTENÇÃO



Cozinha | Lavatório
CLASSIC | SLIM - 5/8



TORNEIRA BICA FIXA
 BASE PARA **BANCADA**



	Código	Acab.	Abertura	Material
	27797	2030	1/4 Volta	Metal
	27798	2040	1/4 Volta	Metal
	27799	2050	1/4 Volta	Metal



Cozinha | Lavatório
CLASSIC | CLINIC



TORNEIRA BICA FIXA
 BASE PARA **BANCADA**



Código	Acab.	Abertura	Material
26399	1020 Clinic	1/4 Volta	Metal
27183	1030 Clinic	1/4 Volta	Metal
27186	1035 Clinic	1/4 Volta	Metal
27189	1040 Clinic	1/4 Volta	Metal
27192	1045 Clinic	1/4 Volta	Metal



BLISTER



DICAS DE USO
 E MANUTENÇÃO





TORNEIRA BICA ALTA MÓVEL
BASE PARA PAREDE



Código	Acab.	Abertura	Material
28155	C17	1/4 Volta	Metal
11073	C31	1/4 Volta	Metal
28163	C38	1/4 Volta	Metal
25848	C39	1/4 Volta	Metal
11074	C40	1/4 Volta	Metal
10965	C50	1/4 Volta	Metal
11075	C52	1/4 Volta	Metal
25847	C55	1/4 Volta	Metal
14300	C70	1/4 Volta	Metal
21000	C90	1/4 Volta	Metal
27245	CLINIC	1/4 Volta	Metal

Código	Acab.	Abertura	Material
23103	MONOC	1/4 Volta	Bica, Acab. ABS





TORNEIRA BICA ALTA MÓVEL
BASE PARA **BANCADA**



Código	Acab.	Abertura	Material
28159	C17	1/4 Volta	Metal
11084	C31	1/4 Volta	Metal
28160	C38	1/4 Volta	Metal
28162	C39	1/4 Volta	Metal
11085	C40	1/4 Volta	Metal
11086	C50	1/4 Volta	Metal
11087	C52	1/4 Volta	Metal
28161	C55	1/4 Volta	Metal
14301	C70	1/4 Volta	Metal
21001	C90	1/4 Volta	Metal



Código	Acab.	Abertura	Material
23100	MONOC	1/4 Volta	Bica Acab. ABS





TORNEIRA BICA MÓVEL
BASE PARA **BANCADA**



C17



C31



C38



C39



C40



C50



C52



C55



C70



C90

Código	Acab.	Abertura	Material
28165	C17	1/4 Volta	Metal
11093	C31	1/4 Volta	Metal
28164	C38	1/4 Volta	Metal
25850	C39	1/4 Volta	Metal
11094	C40	1/4 Volta	Metal
11095	C50	1/4 Volta	Metal
11096	C52	1/4 Volta	Metal
25849	C55	1/4 Volta	Metal
11229	C70	1/4 Volta	Metal
21007	C90	1/4 Volta	Metal

Código	Acab.	Abertura	Material
23063	MONOC	1/4 Volta	Bica, Acab ABS





TORNEIRA BICA FIXA
BASE PARA **BANCADA**



Código	Acab.	Abertura	Material
29171	Baixa Quadrada	1/4 Volta	Metal
29172	Alta Quadrada	1/4 Volta	Metal



Automática
1197 | METAL

TORNEIRA BICA FIXA
BASE PARA **BANCADA**



JÚNIOR

LUXO

Código	Acab.	Abertura	Material
8154	1197 Junior	Automática	Metal
8151	1197 Luxo	Automática	Metal
24004	Valvula Mictório	Automática	Metal/Inox



VÁLVULA
MICTÓRIO



Linha
PRIMEBLACK
banheiros

VEJA NO
AMBIENTE
DECORADO

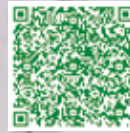

28974
1416 REGISTRO
PRESSÃO 1/2 C90



28977
1416 REGISTRO
PRESSÃO 3/4 C90



28980
1416 REGISTRO
PRESSÃO 3/4 C90



28984
1509 REGISTRO
GAVETA 1/2 C90



28988
1509 REGISTRO
GAVETA 3/4 C90



28125
ACABAMENTO
COMPLETO P/
REGISTRO C90

29779*
PORTA
TOALHA
RETO



29771*
PORTA PAPEL
HIGIÊNICO



29793*
PORTA
TOALHA
ROSTO



29775*
CABIDE

29767*
PORTA
SABONETE



27620
KIT BANHEIRO
5 PEÇAS LUXO

29594
1995 CHUVEIRO
ARTICULADO
C/ DUCHA
E DESVIADOR



29641
1990 DUCHA 20X20
REDONDA

29590
1994 DUCHA
ARTICULADA



27159
1035 TORNEIRA
LAVATÓRIO



27162
1045 TORNEIRA
LAVATÓRIO



28902
1030 TORNEIRA
LAVATÓRIO



27543
1605 VÁLVULA
CLICK



29603
VÁLVULA CLICK
LAVATÓRIO 7/8



29599
1603 VÁLVULA
PARA LAVATÓRIO



29628
1740 REGISTRO
DESVIADOR
C/ DUCHA
HIGIÊNICA C90



29580
1739 DUCHA
HIGIÊNICA C90



29617
ENGATE FLEXÍVEL
INOX 40CM



29621
ENGATE FLEXÍVEL
INOX 60CM

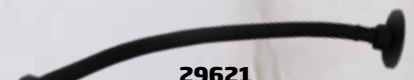

* PEÇAS VENDIDAS AVULSAS (SEPARADAMENTE)

Linha QUADRA PRIMEBLACK banheiro

VEJA NO
AMBIENTE
DECORADO



29808*
PORTA
TOALHA
RETO

29803*
PORTA
TOALHA
ROSTO

29798*
CABIDE

29813*
PORTA PAPEL
HIGIÊNICO

29823*
PORTA
SABONETE

29818*
PORTA
SHAMPOO

29105
KIT BANHEIRO
SQUARE LUXO

29843*
PORTA
TOALHA
RETO

29838*
PORTA
TOALHA
ROSTO

29828*
CABIDE

29833*
PORTA PAPEL
HIGIÊNICO

29854*
PORTA
SABONETE

29849*
PORTA
SHAMPOO

29098
KIT BANHEIRO
QUADRADO LUXO

29968*
PORTA TOALHA
RETO

29964*
PORTA PAPEL
HIGIÊNICO

29972*
PORTA
TOALHA
ROSTO

29960*
CABIDE

29976*
PORTA
SABONETE

29100
KIT BANHEIRO
STANDARD
QUADRADO

* PEÇAS VENDIDAS AVULSAS (SEPARADAMENTE)

29143
ACABAMENTO
ALAVANCA
QUADRA - DECA

29140
ACABAMENTO
MONOCOMANDO
QUADRA - DECA

30728
ACABAMENTO
1.1/2 COMPLETO
P/ REGISTRO
QUADRA

28865
ACABAMENTO
3/4 COMPLETO
P/ REGISTRO
QUADRA

29696
1991 DUCHA 20X20
QUADRADA

28895
4030 TORNEIRA
QUADRA
LAVATÓRIO

28896
4040 TORNEIRA
QUADRA
LAVATÓRIO

28897
4050 TORNEIRA
QUADRA
LAVATÓRIO

29364
1739 DUCHA
HIGIÊNICA
QUADRA

27397
ACABAMENTO P/
VÁLVULA DE DESCARGA
ABS DECA/DOCOL

28894
RALO CLICK
10 X 10

29613
RALO CLICK
15 X 15

29681
1559 SIFÃO MULTIUSO
UNIVERSAL ABS

29632
1684 SIFÃO MULTIUSO
UNIVERSAL SIMPLES ABS

Linha
PRIMEGOLD
banheiros

VEJA NO
AMBIENTE
DECORADO



28975
1416 REGISTRO
PRESSÃO 1/2 C90



28978
1416 REGISTRO
PRESSÃO 3/4 C90



28981
1416 REGISTRO
PRESSÃO 3/4 C90



28985
1509 REGISTRO
GAVETA 1/2 C90



28989
1509 REGISTRO
GAVETA 3/4 C90



28126
ACABAMENTO
COMPLETO P/
REGISTRO C90

29780*
PORTA
TOALHA
RETO



29772*
PORTA PAPEL
HIGIÊNICO



29794*
PORTA
TOALHA
ROSTO



29776*
CABIDE

29768*
PORTA
SABONETE

27618
KIT BANHEIRO
5 PEÇAS LUXO

29597
1995 CHUVEIRO
ARTICULADO
C/ DUCHA
E DESVIADOR



29644
1990 DUCHA 20X20
REDONDA

1/4



29592
1994 DUCHA
ARTICULADA

1/4



27158
1035 TORNEIRA
LAVATÓRIO

1/4



28903
1030 TORNEIRA
LAVATÓRIO

1/4



29608
1605 VÁLVULA
CLICK

27161
1045 TORNEIRA
LAVATÓRIO

29605
VÁLVULA CLICK
LAVATÓRIO 7/8

29601
1603 VÁLVULA
PARA LAVATÓRIO



29630
1740 REGISTRO
DESVIADOR
C/ DUCHA
HIGIÊNICA C90



29582
1739 DUCHA
HIGIÊNICA C90

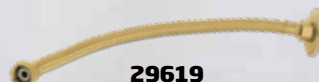

29619
ENGATE FLEXÍVEL
INOX 40CM

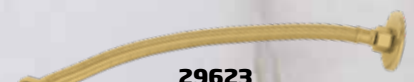

29623
ENGATE FLEXÍVEL
INOX 60CM

* PEÇAS VENDIDAS AVULSAS (SEPARADAMENTE)

Linha QUADRA PRIME GOLD banheiros

VEJA NO
AMBIENTE
DECORADO



29809*
PORTA
TOALHA
RETO



29804*
PORTA
TOALHA
ROSTO



29799*
CABIDE

29814*
PORTA PAPEL
HIGIÊNICO



29824*
PORTA
SABONETE



29819*
PORTA
SHAMPOO

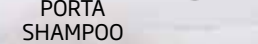

29705
KIT BANHEIRO
SQUARE LUXO

29844*
PORTA
TOALHA
RETO



29839*
PORTA
TOALHA
ROSTO



29829*
CABIDE

29834*
PORTA PAPEL
HIGIÊNICO



29855*
PORTA
SABONETE



29850*
PORTA
SHAMPOO

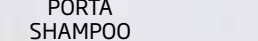

29722
KIT BANHEIRO
QUADRADO LUXO

29970*
PORTA TOALHA
RETO



29966*
PORTA PAPEL
HIGIÊNICO



29974*
PORTA
TOALHA
ROSTO



29962*
CABIDE



29978*
PORTA
SABONETE

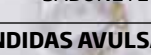

29727
KIT BANHEIRO
STANDARD
QUADRADO

29791
ACABAMENTO
ALAVANCA
QUADRA - DECA



29789
ACABAMENTO
MONOCOMANDO
QUADRA - DECA



30729
ACABAMENTO
1.1/2 COMPLETO
P/ REGISTRO
QUADRA



28866
ACABAMENTO
COMPLETO P/
REGISTRO
QUADRA



29434
1991 DUCHA 20X20
QUADRADA



29690
4030 TORNEIRA
QUADRA
LAVATÓRIO



29694
4040 TORNEIRA
QUADRA
LAVATÓRIO



29785
4050 TORNEIRA
QUADRA
LAVATÓRIO



29626
1739 DUCHA
HIGIÊNICA
QUADRA



27396
ACABAMENTO P/
VÁLVULA DE DESCARGA
ABS DECA/DOCOL



29611
RALO CLICK
10 X 10



29615
RALO CLICK
15 X 15

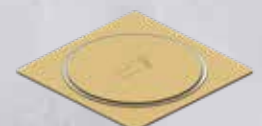

29680
1559 SIFÃO MULTIUSO
UNIVERSAL ABS



29634
1684 SIFÃO MULTIUSO
UNIVERSAL SIMPLES ABS



* PEÇAS VENDIDAS AVULSAS (SEPARADAMENTE)

Linha
PRIME ROSE
banheiros

VEJA NO
AMBIENTE
DECORADO



28976
1416 REGISTRO
PRESSÃO 1/2 C90



28979
1416 REGISTRO
PRESSÃO 3/4 C90



28982
1416 REGISTRO
PRESSÃO 3/4 C90



28986
1509 REGISTRO
GAVETA 1/2 C90



28990
1509 REGISTRO
GAVETA 3/4 C90



28127
ACABAMENTO
COMPLETO P/
REGISTRO C90

29781*
PORTA
TOALHA
RETO

29773*
PORTA PAPEL
HIGIÊNICO

29795*
PORTA
TOALHA
ROSTO

29777*
CABIDE

29769*
PORTA
SABONETE

27619
KIT BANHEIRO
5 PEÇAS LUXO

29598
1995 CHUVEIRO
ARTICULADO
C/ DUCHA
E DESVIADOR

29645
1990 DUCHA 20X20
REDONDA

29593
1994 DUCHA
ARTICULADA

27156
1035 TORNEIRA
LAVATÓRIO

27160
1045 TORNEIRA
LAVATÓRIO

28904
1030 TORNEIRA
LAVATÓRIO

29609
1605 VÁLVULA
CLICK

29606
VÁLVULA CLICK
LAVATÓRIO 7/8

29602
1603 VÁLVULA
PARA LAVATÓRIO

29631
1740 REGISTRO
DESVIADOR
C/ DUCHA
HIGIÊNICA C90

29583
1739 DUCHA
HIGIÊNICA C90

29620
ENGATE FLEXÍVEL
INOX 40CM

29624
ENGATE FLEXÍVEL
INOX 60CM

* PEÇAS VENDIDAS AVULSAS (SEPARADAMENTE)

Linha QUADRA PRIME ROSE banheiros

VEJA NO
AMBIENTE
DECORADO



29810*
PORTA
TOALHA
RETO



29805*
PORTA
TOALHA
ROSTO



29800*
CABIDE



29815*
PORTA PAPEL
HIGIÊNICO



29825*
PORTA
SABONETE

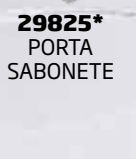

29820*
PORTA
SHAMPOO

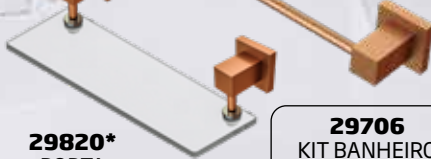

29706
KIT BANHEIRO
SQUARE LUXO

29845*
PORTA
TOALHA
RETO



29840*
PORTA
TOALHA
ROSTO



29830*
CABIDE



29835*
PORTA PAPEL
HIGIÊNICO



29856*
PORTA
SABONETE



29851*
PORTA
SHAMPOO

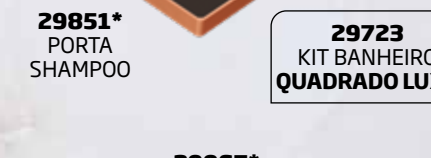

29723
KIT BANHEIRO
QUADRADO LUXO

29971*
PORTA TOALHA
RETO



29967*
PORTA PAPEL
HIGIÊNICO



29975*
PORTA
TOALHA
ROSTO



29963*
CABIDE



29979*
PORTA
SABONETE



29727
KIT BANHEIRO
STANDARD
QUADRADO



29792
ACABAMENTO
ALAVANCA
QUADRA - DECA



29790
ACABAMENTO
MONOCOMANDO
QUADRA - DECA



30730
ACABAMENTO
1.1/2 COMPLETO
P/ REGISTRO
QUADRA

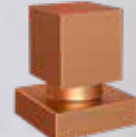

28867
ACABAMENTO
COMPLETO P/
REGISTRO
QUADRA



29433
1991 DUCHA 20X20
QUADRADA



29691
4030 TORNEIRA
QUADRA
LAVATÓRIO



29695
4040 TORNEIRA
QUADRA
LAVATÓRIO



29786
4050 TORNEIRA
QUADRA
LAVATÓRIO



29627
1739 DUCHA
HIGIÊNICA
QUADRA



27395
ACABAMENTO P/
VÁLVULA DE DESCARGA
ABS DECA/DOCOL



29612
RALO CLICK
10 X 10

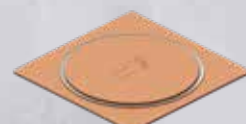

29616
RALO CLICK
15 X 15



29679
1559 SIFÃO MULTIUSO
UNIVERSAL ABS



29635
1684 SIFÃO MULTIUSO
UNIVERSAL SIMPLES ABS

* PEÇAS VENDIDAS AVULSAS (SEPARADAMENTE)

Linha
PRIMECORTEN
banheiros

VEJA NO
AMBIENTE
DECORADO



29646
1416 REGISTRO
PRESSÃO 1/2 C90



29647
1416 REGISTRO
PRESSÃO 3/4 C90



29648
1416 REGISTRO
PRESSÃO 3/4 C90



29649
1509 REGISTRO
GAVETA 1/2 C90



29650
1509 REGISTRO
GAVETA 3/4 C90



29651
ACABAMENTO
COMPLETO P/
REGISTRO C90

29782*
PORTA
TOALHA
RETO

29774*
PORTA PAPEL
HIGIÊNICO

29796*
PORTA
TOALHA
ROSTO

29778*
CABIDE

29770*
PORTA
SABONETE

29102
KIT BANHEIRO
5 PEÇAS LUXO

29596
1995 CHUVEIRO
ARTICULADO
C/ DUCHA
E DESVIADOR

29643
1990 DUCHA 20X20
REDONDA

29591
1994 DUCHA
ARTICULADA

29094
1035 TORNEIRA
LAVATÓRIO

29095
1045 TORNEIRA
LAVATÓRIO

29093
1030 TORNEIRA
LAVATÓRIO

29607
1605 VÁLVULA
CLICK

29604
VÁLVULA CLICK
LAVATÓRIO 7/8

29600
1603 VÁLVULA
PARA LAVATÓRIO

29629
1740 REGISTRO
DESVIADOR
C/ DUCHA
HIGIÊNICA C90

29581
1739 DUCHA
HIGIÊNICA C90

29618
ENGATE FLEXÍVEL
INOX 40CM

29622
ENGATE FLEXÍVEL
INOX 60CM

* PEÇAS VENDIDAS AVULSAS (SEPARADAMENTE)

Linha QUADRA PRIMECORTEN banheiros

VEJA NO
AMBIENTE
DECORADO



29811*
PORTA
TOALHA
RETO



29806*
PORTA
TOALHA
ROSTO



29801*
CABIDE



29816*
PORTA PAPEL
HIGIÊNICO



29826*
PORTA
SABONETE

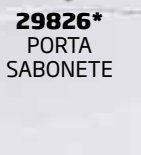

29821*
PORTA
SHAMPOO



29106
KIT BANHEIRO
SQUARE LUXO

29846*
PORTA
TOALHA
RETO



29841*
PORTA
TOALHA
ROSTO



29831*
CABIDE



29836*
PORTA PAPEL
HIGIÊNICO



29857*
PORTA
SABONETE



29852*
PORTA
SHAMPOO

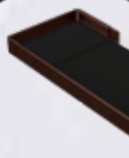

29099
KIT BANHEIRO
QUADRADO LUXO

29969*
PORTA TOALHA
RETO



29965*
PORTA PAPEL
HIGIÊNICO



29973*
PORTA
TOALHA
ROSTO



29961*
CABIDE



29977*
PORTA
SABONETE



29101
KIT BANHEIRO
STANDARD
QUADRADO

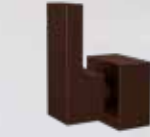

29144
ACABAMENTO
ALAVANCA
QUADRA - DECA



29141
ACABAMENTO
MONOCOMANDO
QUADRA - DECA



30731
ACABAMENTO
1.1/2 COMPLETO
P/ REGISTRO
QUADRA



29339
ACABAMENTO
COMPLETO P/
REGISTRO
QUADRA



29697
1991 DUCHA 20X20
QUADRADA



29689
4030 TORNEIRA
QUADRA
LAVATÓRIO



29693
4040 TORNEIRA
QUADRA
LAVATÓRIO



29787
4050 TORNEIRA
QUADRA
LAVATÓRIO



29625
1739 DUCHA
HIGIÊNICA
QUADRA



29642
ACABAMENTO P/
VÁLVULA DE DESCARGA
ABS DECA/DOCOL



29610
RALO CLICK
10 X 10



29614
RALO CLICK
15 X 15



29682
1559 SIFÃO MULTIUSO
UNIVERSAL ABS



29633
1684 SIFÃO MULTIUSO
UNIVERSAL SIMPLES ABS

* PEÇAS VENDIDAS AVULSAS (SEPARADAMENTE)

Linha
PRIMECROMADA
banheiros



28972
1416 REGISTRO
PRESSÃO 1/2 C90



28973
1416 REGISTRO
PRESSÃO 3/4 C90



21129
1416 REGISTRO
PRESSÃO 3/4 C90



28983
1509 REGISTRO
GAVETA 1/2 C90



28987
1509 REGISTRO
GAVETA 3/4 C90



28456
ACABAMENTO
COMPLETO P/
REGISTRO
1.1/2 C90



21351
ACABAMENTO
COMPLETO P/
REGISTRO
3/4 C90

11152*
PORTA
TOALHA
RETO

11156*
PORTA PAPEL
HIGIÊNICO

11153*
PORTA
TOALHA
ROSTO

11154*
CABIDE

11155*
PORTA
SABONETE

1278
KIT BANHEIRO
5 PEÇAS LUXO

28909
1990 DUCHA 20X20
REDONDA

5893
1995 CHUVEIRO
ARTICULADO
C/ DUCHA
E DESVIADOR

8667
1020 TORNEIRA
LAVATÓRIO

5242
1994 DUCHA
ARTICULADA

8670
1030 TORNEIRA
LAVATÓRIO

8673
1040 TORNEIRA
LAVATÓRIO

26532
1035 TORNEIRA
LAVATÓRIO

8676
1050 TORNEIRA
LAVATÓRIO

26533
1045 TORNEIRA
LAVATÓRIO

15176
1605 VÁLVULA
CLICK

25277
VÁLVULA CLICK
LAVATÓRIO 7/8

4818
1603 VÁLVULA
PARA LAVATÓRIO

21233
1740 REGISTRO
DESVIADOR
C/ DUCHA
HIGIÊNICA C90

21024
1739 DUCHA
HIGIÊNICA C90

8952
ENGATE FLEXÍVEL
INOX 40CM

8955
ENGATE FLEXÍVEL
INOX 60CM

* PEÇAS VENDIDAS AVULSAS (SEPARADAMENTE)

Linha QUADRA

PRIME CROMADA

banheiros



29807*
PORTA
TOALHA
RETO

29802*
PORTA
TOALHA
ROSTO

29797*
CABIDE

29812*
PORTA PAPEL
HIGIÊNICO

29145
ACABAMENTO
ALAVANCA
QUADRA - DECA

29142
ACABAMENTO
MONOCOMANDO
QUADRA - DECA

28868
ACABAMENTO
1.1/2 COMPLETO
P/ REGISTRO
QUADRA

28864
ACABAMENTO
3/4 COMPLETO
P/ REGISTRO
QUADRA

29822*
PORTA
SABONETE

29817*
PORTA
SHAMPOO

29074
KIT BANHEIRO
SQUARE LUXO

28910
1991 DUCHA 20X20
QUADRADA

29842*
PORTA
TOALHA
RETO

29837*
PORTA
TOALHA
ROSTO

29827*
CABIDE

29832*
PORTA PAPEL
HIGIÊNICO

29688
4030 TORNEIRA
QUADRA
LAVATÓRIO

29692
4040 TORNEIRA
QUADRA
LAVATÓRIO

29853*
PORTA
SABONETE

29848*
PORTA
SHAMPOO

5826
KIT BANHEIRO
QUADRADO LUXO

29788
4050 TORNEIRA
QUADRA
LAVATÓRIO

29365
1739 DUCHA
HIGIÊNICA
QUADRA

5203*
PORTA TOALHA
RETO

5212*
PORTA PAPEL
HIGIÊNICO

5199*
PORTA
TOALHA
ROSTO

16895
ACABAMENTO P/
VÁLVULA DE DESCARGA
ABS DECA/DOCOL

24324
RALO CLICK
10 X 10

26637
RALO CLICK
15 X 15

5218*
CABIDE

5215*
PORTA
SABONETE

25543
KIT BANHEIRO
STANDARD
QUADRADO

29686
1559 SIFÃO MULTIUSO
UNIVERSAL ABS

30030
1684 SIFÃO MULTIUSO
UNIVERSAL SIMPLES ABS

* PEÇAS VENDIDAS AVULSAS (SEPARADAMENTE)

Purificador de Água Color Flex 2168 | METAL

TORNEIRA BICA FLEXÍVEL
BASE PARA **BANCADA**

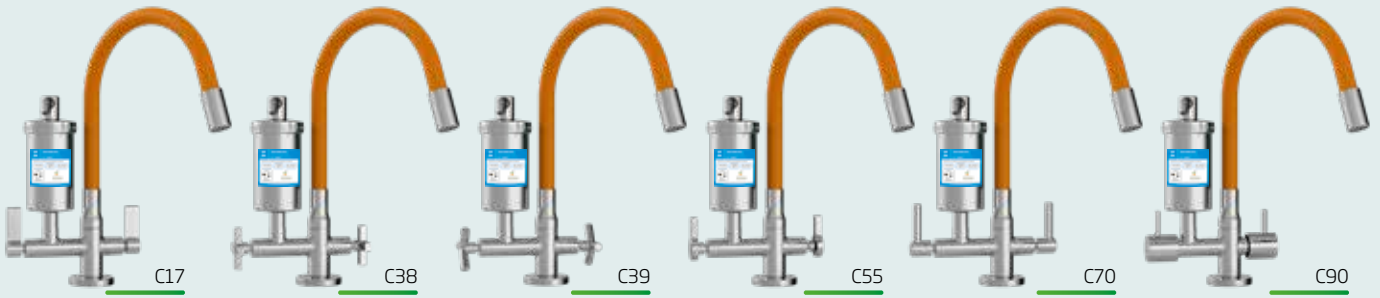

Código	Acab.	Abertura	Material
28299	C17	1/4 Volta	Metal/Flex Branco
28300	C38	1/4 Volta	Metal/Flex Branco
28301	C39	1/4 Volta	Metal/Flex Branco
28302	C55	1/4 Volta	Metal/Flex Branco
26813	C70	1/4 Volta	Metal/Flex Branco
26817	C90	1/4 Volta	Metal/Flex Branco
28303	C17	1/4 Volta	Metal/Flex Laranja
28304	C38	1/4 Volta	Metal/Flex Laranja
28305	C39	1/4 Volta	Metal/Flex Laranja
28306	C55	1/4 Volta	Metal/Flex Laranja
26814	C70	1/4 Volta	Metal/Flex Laranja
26818	C90	1/4 Volta	Metal/Flex Laranja
28307	C17	1/4 Volta	Metal/Flex Preto
28308	C38	1/4 Volta	Metal/Flex Preto
28309	C39	1/4 Volta	Metal/Flex Preto
28310	C55	1/4 Volta	Metal/Flex Preto
26811	C70	1/4 Volta	Metal/Flex Preto
26815	C90	1/4 Volta	Metal/Flex Preto
28311	C17	1/4 Volta	Metal/Flex Vermelho
28312	C38	1/4 Volta	Metal/Flex Vermelho
28313	C39	1/4 Volta	Metal/Flex Vermelho
28314	C55	1/4 Volta	Metal/Flex Vermelho
26812	C70	1/4 Volta	Metal/Flex Vermelho
26816	C90	1/4 Volta	Metal/Flex Vermelho

DICAS DE USO
E MANUTENÇÃO



VELA
PRÓ-SAÚDE



17784

1/4



15686



Purificador de Água Color Flex 2168 | METAL - COPO ABS

TORNEIRA BICA FLEXÍVEL
BASE PARA **BANCADA**

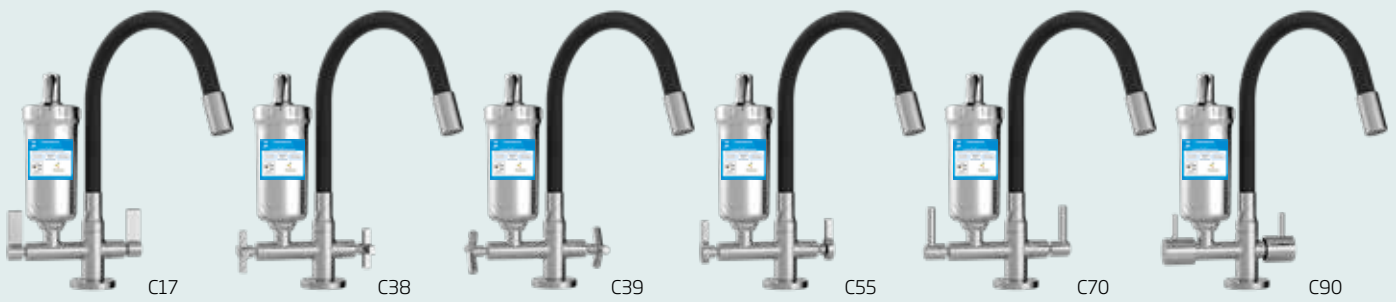
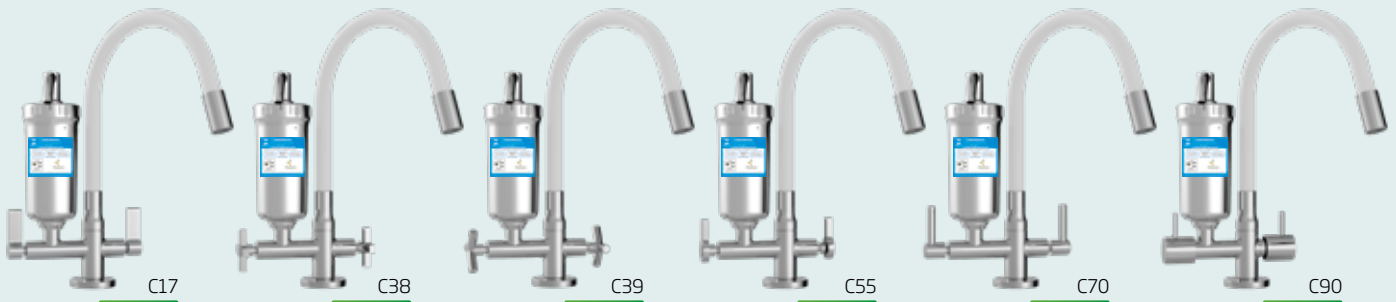

Código	Acab.	Abertura	Material
28282	C17	1/4 Volta	Metal/Flex Branco/Copo ABS
28283	C38	1/4 Volta	Metal/Flex Branco/Copo ABS
28284	C39	1/4 Volta	Metal/Flex Branco/Copo ABS
28285	C55	1/4 Volta	Metal/Flex Branco/Copo ABS
26806	C70	1/4 Volta	Metal/Flex Branco/Copo ABS
26809	C90	1/4 Volta	Metal/Flex Branco/Copo ABS
28286	C17	1/4 Volta	Metal/Flex Laranja/Copo ABS
28287	C38	1/4 Volta	Metal/Flex Laranja/Copo ABS
28288	C39	1/4 Volta	Metal/Flex Laranja/Copo ABS
28289	C55	1/4 Volta	Metal/Flex Laranja/Copo ABS
26807	C70	1/4 Volta	Metal/Flex Laranja/Copo ABS
26810	C90	1/4 Volta	Metal/Flex Laranja/Copo ABS
28290	C17	1/4 Volta	Metal/Flex Preto/Copo ABS
28291	C38	1/4 Volta	Metal/Flex Preto/Copo ABS
28292	C39	1/4 Volta	Metal/Flex Preto/Copo ABS
28293	C55	1/4 Volta	Metal/Flex Preto/Copo ABS
26803	C70	1/4 Volta	Metal/Flex Preto/Copo ABS
26804	C90	1/4 Volta	Metal/Flex Preto/Copo ABS
28294	C17	1/4 Volta	Metal/Flex Vermelho/Copo ABS
28295	C38	1/4 Volta	Metal/Flex Vermelho/Copo ABS
28296	C39	1/4 Volta	Metal/Flex Vermelho/Copo ABS
28297	C55	1/4 Volta	Metal/Flex Vermelho/Copo ABS
26805	C70	1/4 Volta	Metal/Flex Vermelho/Copo ABS
26808	C90	1/4 Volta	Metal/Flex Vermelho/Copo ABS

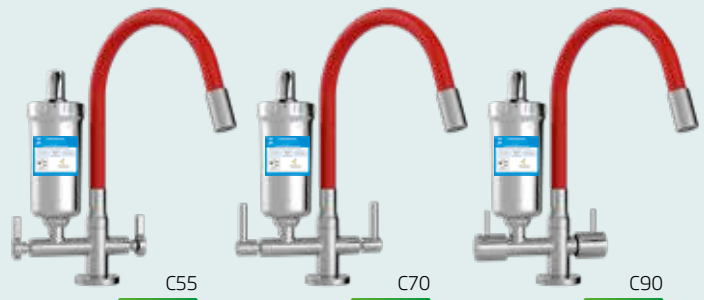

Purificador de Água Gourmet 2168 | METAL

TORNEIRA BICA FLEXÍVEL
BASE PARA **BANCADA**



Código	Acab.	Abertura	Material
28268	C17	1/4 Volta	Metal/Bica Gourmet
28269	C38	1/4 Volta	Metal/Bica Gourmet
28270	C39	1/4 Volta	Metal/Bica Gourmet
28271	C55	1/4 Volta	Metal/Bica Gourmet
26796	C70	1/4 Volta	Metal/Bica Gourmet
26797	C90	1/4 Volta	Metal/Bica Gourmet

CAIXA BLISTER

VELA PRO-SAÚDE
17784

VELA MART
17783

1/4
15686

GARANTIA
12 ANOS

10
CAIXA FECHADA

Purificador de Água Gourmet 2168 | METAL - COPO ABS

TORNEIRA BICA FLEXÍVEL
BASE PARA **BANCADA**



Código	Acab.	Abertura	Material
28264	C17	1/4 Volta	Metal/Bica Gourmet/Copo ABS
28265	C38	1/4 Volta	Metal/Bica Gourmet/Copo ABS
28266	C39	1/4 Volta	Metal/Bica Gourmet/Copo ABS
28267	C55	1/4 Volta	Metal/Bica Gourmet/Copo ABS
26794	C70	1/4 Volta	Metal/Bica Gourmet/Copo ABS
26795	C90	1/4 Volta	Metal/Bica Gourmet/Copo ABS

CAIXA BLISTER

VELA PRO-SAÚDE
17784

VELA MART
17783

1/4
15686

GARANTIA
12 ANOS

10
CAIXA FECHADA

Purificador de Água Gourmet Duo 2168 | METAL

TORNEIRA BICA FLEXÍVEL
BASE PARA **BANCADA**



Código	Acab.	Abertura	Material
28277	C17	1/4 Volta	Metal/Bica Gourmet Duo
28278	C38	1/4 Volta	Metal/Bica Gourmet Duo
28279	C39	1/4 Volta	Metal/Bica Gourmet Duo
28280	C55	1/4 Volta	Metal/Bica Gourmet Duo
27693	C70	1/4 Volta	Metal/Bica Gourmet Duo
28281	C90	1/4 Volta	Metal/Bica Gourmet Duo



1/4

VELA PRO-SAÚDE



Purificador de Água Gourmet Duo 2168 | METAL - COPO ABS

TORNEIRA BICA FLEXÍVEL
BASE PARA **BANCADA**



Código	Acab.	Abertura	Material
28272	C17	1/4 Volta	Metal/Bica Gourmet Duo/Copo ABS
28273	C38	1/4 Volta	Metal/Bica Gourmet Duo/Copo ABS
28274	C39	1/4 Volta	Metal/Bica Gourmet Duo/Copo ABS
28275	C55	1/4 Volta	Metal/Bica Gourmet Duo/Copo ABS
27699	C70	1/4 Volta	Metal/Bica Gourmet Duo/Copo ABS
28276	C90	1/4 Volta	Metal/Bica Gourmet Duo/Copo ABS



1/4

VELA PRO-SAÚDE



Purificador de Água 2168 | METAL

TORNEIRA BICA MÓVEL
BASE PARA **BANCADA**



C17



C31



C33



C38



C39



C40



C50



C52



C55



C70



C90

Código	Acab.	Abertura	Material
28259	C17	1/4 Volta	Metal
18470	C31	1/4 Volta	Metal
18473	C33	1/4 Volta	Metal
28260	C38	1/4 Volta	Metal
28261	C39	1/4 Volta	Metal
26802	C40	1/4 Volta	Metal
18475	C50	1/4 Volta	Metal
28262	C52	1/4 Volta	Metal
28263	C55	1/4 Volta	Metal
21458	C70	1/4 Volta	Metal
21015	C90	1/4 Volta	Metal

CAIXA BLISTER

VELA PRÓ-SAÚDE
17784

1/4

CAIXA FECHADA

VELA MART
17783

15686

12 ANOS GARANTIA

10 CAIXA FECHADA

17784

15686

1/4

17783

15686

Purificador de Água 2168 | MISTA

TORNEIRA BICA MÓVEL
BASE PARA **BANCADA**



C23



C31



C33



C40



C50



C70

CAIXA BLISTER

VELA PRÓ-SAÚDE
17784

VELA MART
17783

1/4

12 ANOS GARANTIA

10 CAIXA FECHADA

17784

17783

15686

Código	Acab.	Abertura	Material
28253	C23	1/4 Volta	Metal/Copo, Bica e Acab ABS
18472	C31	1/4 Volta	Metal/Copo, Bica e Acab ABS
18474	C33	1/4 Volta	Metal/Copo, Bica e Acab ABS
26798	C40	1/4 Volta	Metal/Copo, Bica e Acab ABS
26799	C50	1/4 Volta	Metal/Copo, Bica e Acab ABS
26800	C70	1/4 Volta	Metal/Copo, Bica e Acab ABS

Purificador de Água 2168 | METAL - COPO ABS

TORNEIRA BICA MÓVEL
BASE PARA **BANCADA**



Código	Acab.	Abertura	Material
28254	C17	1/4 Volta	Metal/Copo ABS
26853	C31	1/4 Volta	Metal/Copo ABS
26786	C33	1/4 Volta	Metal/Copo ABS
28255	C38	1/4 Volta	Metal/Copo ABS
28256	C39	1/4 Volta	Metal/Copo ABS
26790	C40	1/4 Volta	Metal/Copo ABS
26791	C50	1/4 Volta	Metal/Copo ABS
28257	C52	1/4 Volta	Metal/Copo ABS
28258	C55	1/4 Volta	Metal/Copo ABS
26792	C70	1/4 Volta	Metal/Copo ABS
26793	C90	1/4 Volta	Metal/Copo ABS



Modelo purificador tem certificações que comprovam sua eficiência e proteção.

- Com redução de água fria
- Atenuação de partículas
- Com eficiência bactericida

15606 17784 17783

VELA PRO-SAÚDE VELAS MART

CAIXA BLISTER

10 CAIXA FECHADA

12 ANOS GARANTIA

Base 2168 | METAL

BASE BICA FLEXÍVEL
BASE PARA **BANCADA**



Código	Acab.	Abertura	Material
26801	C70	1/4 Volta	Metal
26833	C70	1/4 Volta	Metal/Bica Gourmet
26835	C70	1/4 Volta	Metal/Bica Flex Preta
21332	C90	1/4 Volta	Metal
26834	C90	1/4 Volta	Metal/Bica Gourmet
26839	C90	1/4 Volta	Metal/Bica Flex Preta

15606 10 CAIXA FECHADA

12 ANOS GARANTIA

1/4 CAIXA BLISTER

Purificador de Água Aquaduo 2167 | METAL - COPO ABS

TORNEIRA BICA FLEXÍVEL
BASE PARA PAREDE

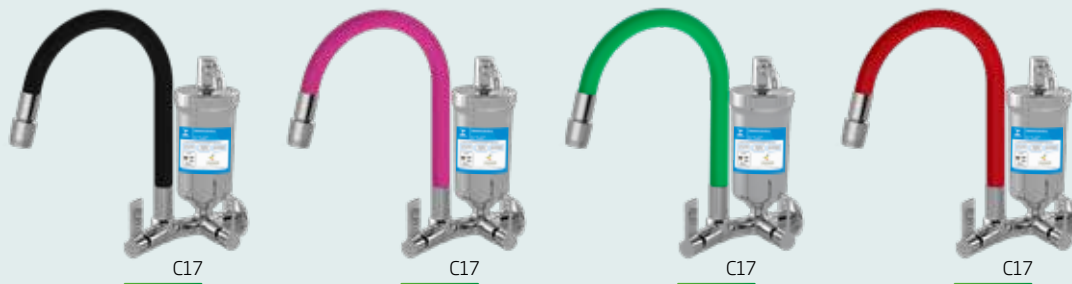

**DICAS DE USO
E MANUTENÇÃO**

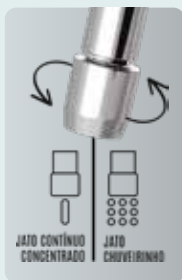

Código	Acab.	Abertura	Material
28400	C17	1/4 Volta	Metal/Copo ABS, Flex Amarelo
28401	C17	1/4 Volta	Metal/Copo ABS, Flex Azul
28402	C17	1/4 Volta	Metal/Copo ABS, Flex Branco
28403	C17	1/4 Volta	Metal/Copo ABS, Flex Cinza
28404	C17	1/4 Volta	Metal/Copo ABS, Flex Laranja
28405	C17	1/4 Volta	Metal/Copo ABS, Flex Preto
28406	C17	1/4 Volta	Metal/Copo ABS, Flex Rosa
28407	C17	1/4 Volta	Metal/Copo ABS, Flex Verde
28408	C17	1/4 Volta	Metal/Copo ABS, Flex Vermelho
9576	C70	1/4 Volta	Metal/Copo ABS, Flex Amarelo
13066	C70	1/4 Volta	Metal/Copo ABS, Flex Azul
9580	C70	1/4 Volta	Metal/Copo ABS, Flex Branco
13461	C70	1/4 Volta	Metal/Copo ABS, Flex Cinza
13073	C70	1/4 Volta	Metal/Copo ABS, Flex Laranja
9584	C70	1/4 Volta	Metal/Copo ABS, Flex Preto
13079	C70	1/4 Volta	Metal/Copo ABS, Flex Rosa
9588	C70	1/4 Volta	Metal/Copo ABS, Flex Verde
13173	C70	1/4 Volta	Metal/Copo ABS, Flex Vermelho



Purificador de Água Color Flex 2167 | METAL - COPO ABS

TORNEIRA BICA FLEXÍVEL
BASE PARA PAREDE

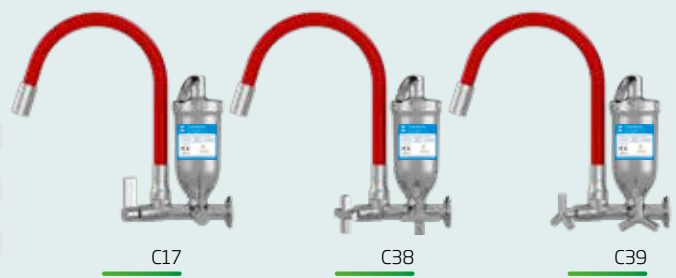
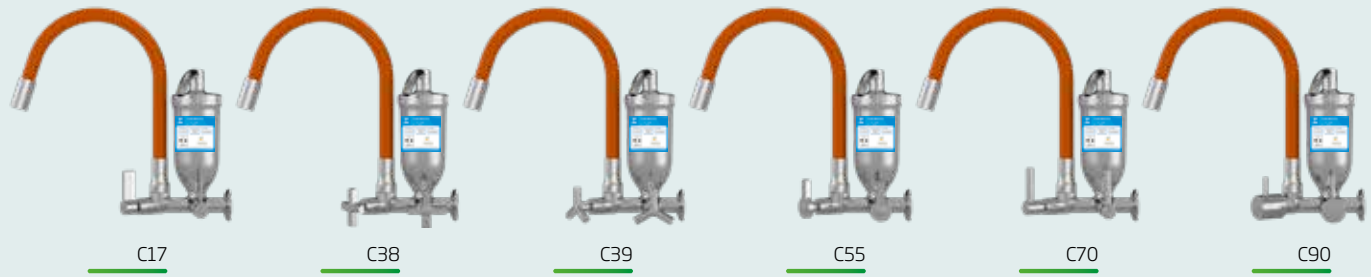
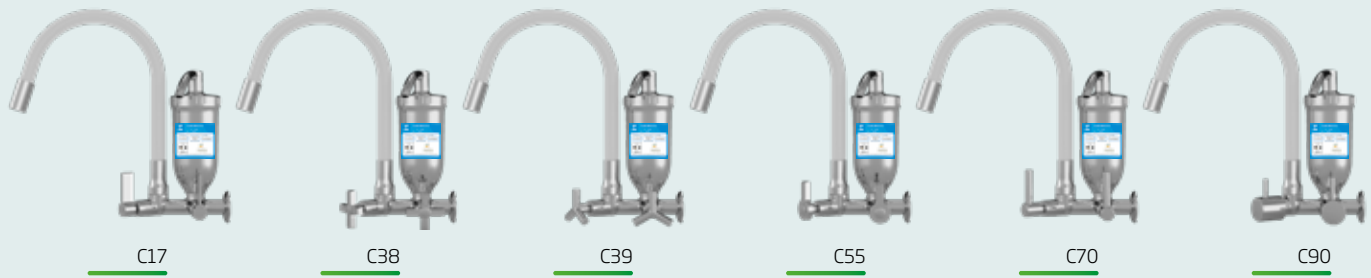

Código	Acab.	Abertura	Material
28992	C17	1/4 Volta	Metal/Flex Branco/Copo ABS
28996	C38	1/4 Volta	Metal/Flex Branco/Copo ABS
29000	C39	1/4 Volta	Metal/Flex Branco/Copo ABS
29004	C55	1/4 Volta	Metal/Flex Branco/Copo ABS
29008	C70	1/4 Volta	Metal/Flex Branco/Copo ABS
29012	C90	1/4 Volta	Metal/Flex Branco/Copo ABS
28993	C17	1/4 Volta	Metal/Flex Laranja/Copo ABS
28997	C38	1/4 Volta	Metal/Flex Laranja/Copo ABS
29001	C39	1/4 Volta	Metal/Flex Laranja/Copo ABS
29005	C55	1/4 Volta	Metal/Flex Laranja/Copo ABS
29009	C70	1/4 Volta	Metal/Flex Laranja/Copo ABS
29013	C90	1/4 Volta	Metal/Flex Laranja/Copo ABS
28994	C17	1/4 Volta	Metal/Flex Preto/Copo ABS
28998	C38	1/4 Volta	Metal/Flex Preto/Copo ABS
29002	C39	1/4 Volta	Metal/Flex Preto/Copo ABS
29006	C55	1/4 Volta	Metal/Flex Preto/Copo ABS
29010	C70	1/4 Volta	Metal/Flex Preto/Copo ABS
29014	C90	1/4 Volta	Metal/Flex Preto/Copo ABS
28995	C17	1/4 Volta	Metal/Flex Vermelho/Copo ABS
28999	C38	1/4 Volta	Metal/Flex Vermelho/Copo ABS
29003	C39	1/4 Volta	Metal/Flex Vermelho/Copo ABS
29007	C55	1/4 Volta	Metal/Flex Vermelho/Copo ABS
29011	C70	1/4 Volta	Metal/Flex Vermelho/Copo ABS
29015	C90	1/4 Volta	Metal/Flex Vermelho/Copo ABS

NOSSOS PRODUTOS TEM CERTIFICAÇÃO QUE GARANTE A SUA SEGURANÇA E BOM USO.

Garantia de 12 anos

1/4"

15606

VELA PRO-SAÚDE

17784

VELA MART

17783

CAIXA BLISTER

10 CAIXA FECHADA

12 ANOS

Purificador de Água Gourmet 2167 | METAL

TORNEIRA BICA FLEXÍVEL
BASE PARA PAREDE



Código	Acab.	Abertura	Material
28247	C17	1/4 Volta	Metal/Bica Gourmet
28248	C38	1/4 Volta	Metal/Bica Gourmet
28249	C39	1/4 Volta	Metal/Bica Gourmet
28250	C55	1/4 Volta	Metal/Bica Gourmet
25424	C70	1/4 Volta	Metal/Bica Gourmet
28251	C90	1/4 Volta	Metal/Bica Gourmet

Purificador de Água Gourmet 2167 | METAL - COPO ABS

TORNEIRA BICA FLEXÍVEL
BASE PARA PAREDE

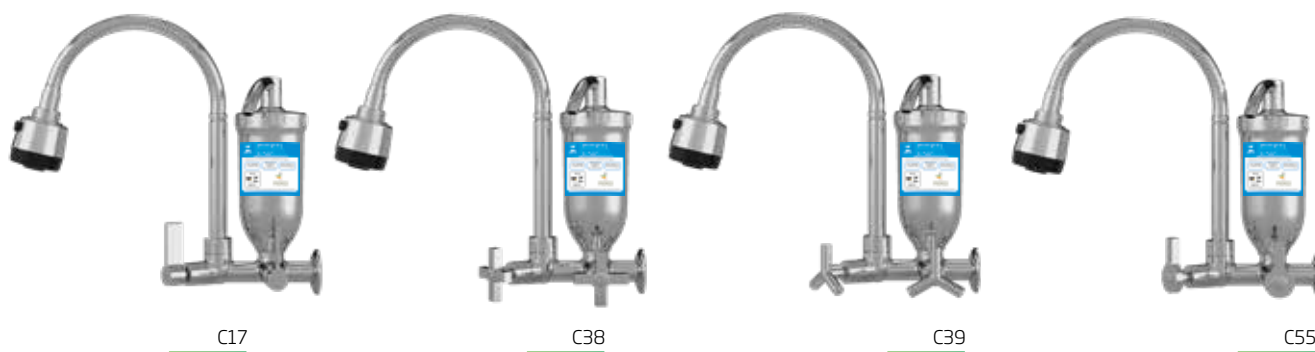

Código	Acab.	Abertura	Material
28239	C17	1/4 Volta	Metal/Bica Gourmet/Copo ABS
28242	C38	1/4 Volta	Metal/Bica Gourmet/Copo ABS
28243	C39	1/4 Volta	Metal/Bica Gourmet/Copo ABS
28245	C55	1/4 Volta	Metal/Bica Gourmet/Copo ABS
23772	C70	1/4 Volta	Metal/Bica Gourmet/Copo ABS
28246	C90	1/4 Volta	Metal/Bica Gourmet/Copo ABS

Purificador de Água Gourmet Duo 2167 | METAL - COPO ABS

TORNEIRA BICA FLEXÍVEL
BASE PARA PAREDE



Código	Acab.	Abertura	Material
29016	C17	1/4 Volta	Metal/Bica Gourmet Duo/Copo ABS
29017	C38	1/4 Volta	Metal/Bica Gourmet Duo/Copo ABS
29018	C39	1/4 Volta	Metal/Bica Gourmet Duo/Copo ABS
29019	C55	1/4 Volta	Metal/Bica Gourmet Duo/Copo ABS
29020	C70	1/4 Volta	Metal/Bica Gourmet Duo/Copo ABS
29021	C90	1/4 Volta	Metal/Bica Gourmet Duo/Copo ABS

VELA PRÓ-SAÚDE

PRIMEIRA EMPRESA DO BRASIL

A CRIAR FILTRO COM VELA SEM CONTATO COM O COPO.

BENEFÍCIOS

- Com carvão ativado e natural para uma filtração completa.
- Elimina gostos e odores desagradáveis na água.
- Refil descartável, não necessita retrolavagem.
- Reduz os índices de cloro presente na água.



2º ELEMENTO FILTRANTE
Tem a finalidade de clarear a água deixando a mesma cristalina

CARVÃO ATIVADO
Reduz o cloro livre absorvendo gostos e odores desagradáveis.

1º ELEMENTO FILTRANTE
Retém partículas sólidas como barro, ferrugem, sujeiras de 15 a 30 micras.

VELA BLINDADA
A água não tem contato com a área interna do copo.

Purificador de Água 2167 | METAL

TORNEIRA BICA MÓVEL
BASE PARA PAREDE

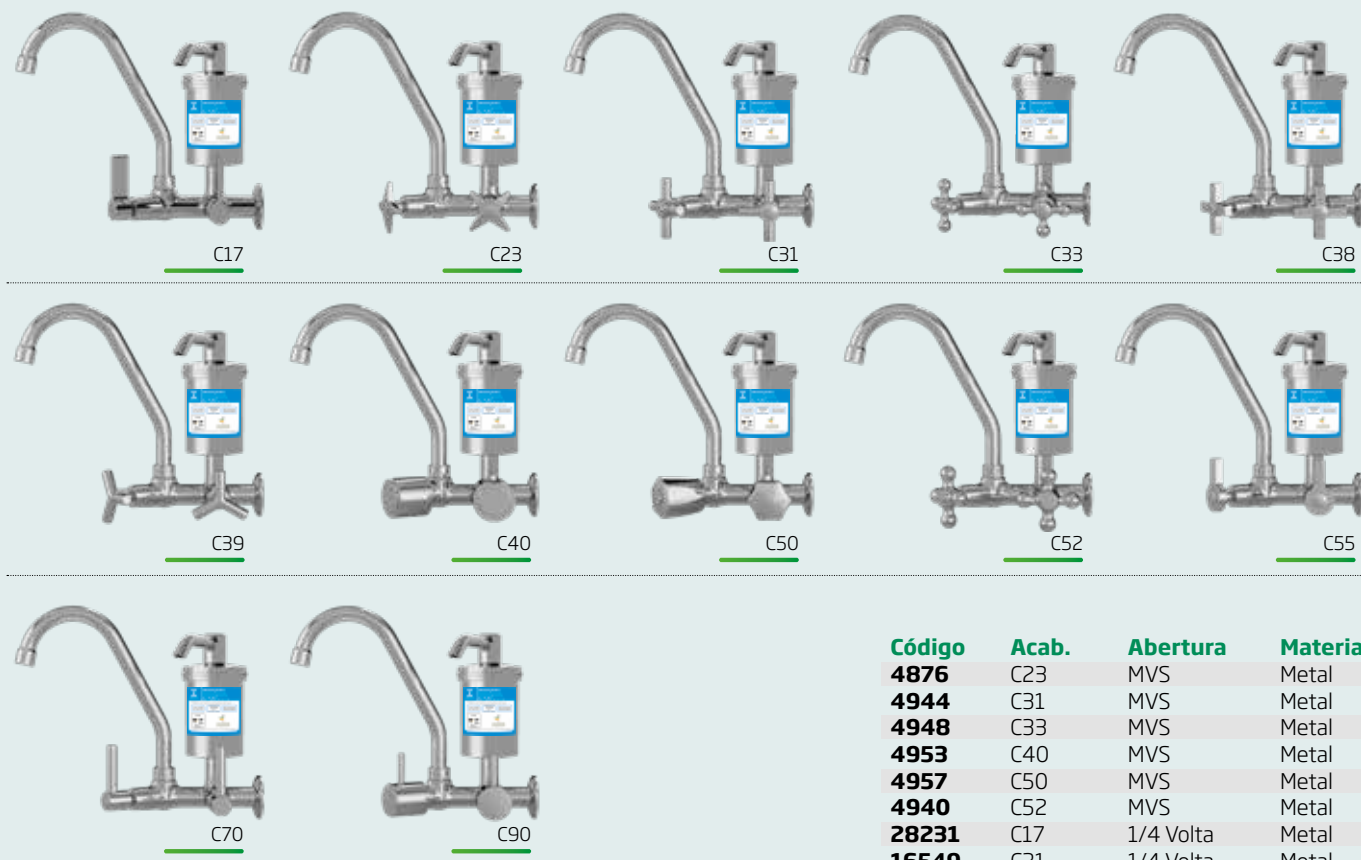

Código	Acab.	Abertura	Material
4876	C23	MVS	Metal
4944	C31	MVS	Metal
4948	C33	MVS	Metal
4953	C40	MVS	Metal
4957	C50	MVS	Metal
4940	C52	MVS	Metal
28231	C17	1/4 Volta	Metal
16549	C31	1/4 Volta	Metal
18145	C33	1/4 Volta	Metal
28232	C38	1/4 Volta	Metal
28233	C39	1/4 Volta	Metal
14248	C40	1/4 Volta	Metal
14266	C50	1/4 Volta	Metal
18480	C52	1/4 Volta	Metal
28234	C55	1/4 Volta	Metal
20706	C70	1/4 Volta	Metal
21016	C90	1/4 Volta	Metal



Purificador de Água 2167 | MISTA

TORNEIRA BICA MÓVEL
BASE PARA PAREDE

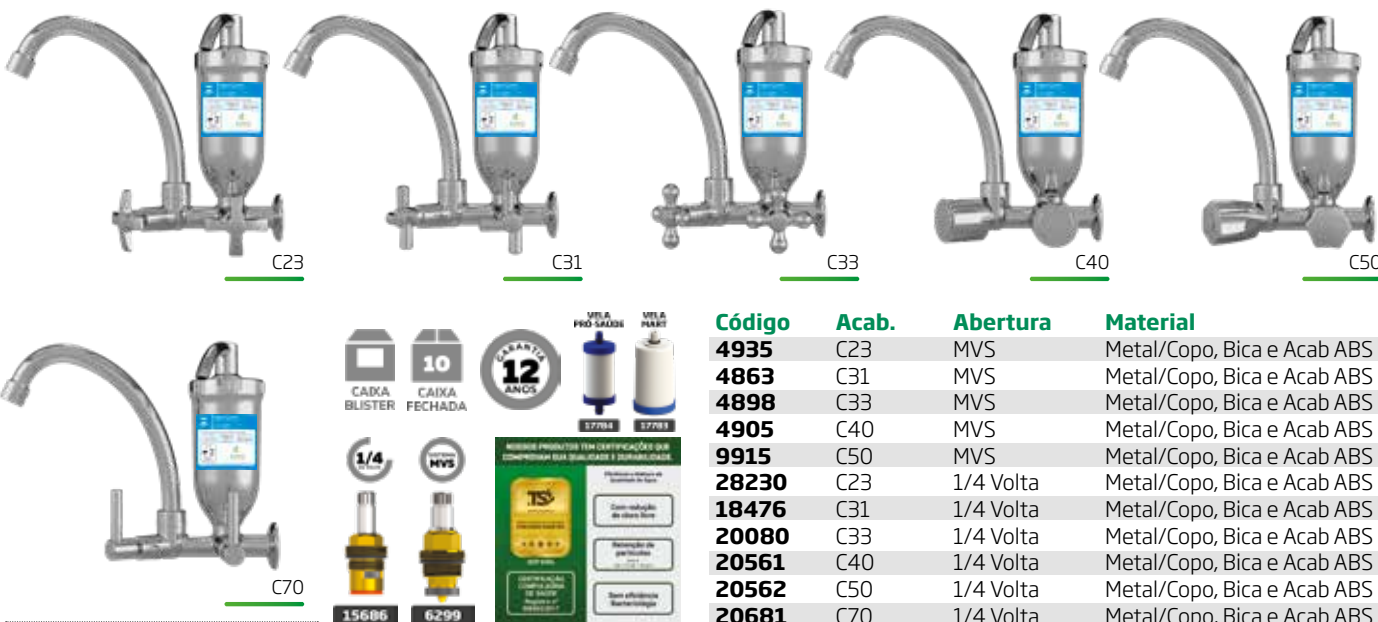

Código	Acab.	Abertura	Material
4935	C23	MVS	Metal/Copo, Bica e Acab ABS
4863	C31	MVS	Metal/Copo, Bica e Acab ABS
4898	C33	MVS	Metal/Copo, Bica e Acab ABS
4905	C40	MVS	Metal/Copo, Bica e Acab ABS
9915	C50	MVS	Metal/Copo, Bica e Acab ABS
28230	C23	1/4 Volta	Metal/Copo, Bica e Acab ABS
18476	C31	1/4 Volta	Metal/Copo, Bica e Acab ABS
20080	C33	1/4 Volta	Metal/Copo, Bica e Acab ABS
20561	C40	1/4 Volta	Metal/Copo, Bica e Acab ABS
20562	C50	1/4 Volta	Metal/Copo, Bica e Acab ABS
20681	C70	1/4 Volta	Metal/Copo, Bica e Acab ABS



Purificador de Água 2167 | METAL - COPO ABS

TORNEIRA BICA MÓVEL
BASE PARA PAREDE



Código	Acab.	Abertura	Material
4960	C23	MVS	Metal/Copo ABS
6322	C31	MVS	Metal/Copo ABS
15232	C33	MVS	Metal/Copo ABS
15234	C40	MVS	Metal/Copo ABS
14169	C50	MVS	Metal/Copo ABS
6227	C52	MVS	Metal/Copo ABS
28235	C17	1/4 Volta	Metal/Copo ABS
20785	C31	1/4 Volta	Metal/Copo ABS
20784	C33	1/4 Volta	Metal/Copo ABS
28236	C38	1/4 Volta	Metal/Copo ABS
28237	C39	1/4 Volta	Metal/Copo ABS
20783	C40	1/4 Volta	Metal/Copo ABS
20782	C50	1/4 Volta	Metal/Copo ABS
21689	C52	1/4 Volta	Metal/Copo ABS
28238	C55	1/4 Volta	Metal/Copo ABS
21891	C70	1/4 Volta	Metal/Copo ABS
21892	C90	1/4 Volta	Metal/Copo ABS



Base 2167 | METAL

BASE BICA FLEXÍVEL
BASE PARA PAREDE



Código	Acab.	Abertura	Material
6186	C23	MVS	Metal
6185	C31	MVS	Metal
6184	C33	MVS	Metal
6187	C40	MVS	Metal
6182	C50	MVS	Metal



Purificador de Água 2159 | METAL

TORNEIRA BICA FIXA
BASE PARA PAREDE



C17



C23



C31



C33



C38



C39



C40



C50



C52



C55



C70



C90

Código	Acab.	Abertura	Material
7071	C23	MVS	Metal
7077	C31	MVS	Metal
7074	C33	MVS	Metal
7080	C40	MVS	Metal
7068	C50	MVS	Metal
7089	C52	MVS	Metal
28315	C17	1/4 Volta	Metal
18435	C31	1/4 Volta	Metal
18439	C33	1/4 Volta	Metal
28316	C38	1/4 Volta	Metal
28317	C39	1/4 Volta	Metal
28318	C40	1/4 Volta	Metal
28319	C50	1/4 Volta	Metal
18469	C52	1/4 Volta	Metal
28320	C55	1/4 Volta	Metal
20686	C70	1/4 Volta	Metal
21014	C90	1/4 Volta	Metal

ESTE PRODUTO TEM CERTIFICAÇÃO QUE COMPROVA SUA QUALIDADE E DURABILIDADE.

Purificador de Água 2159 | METAL - COPO ABS

TORNEIRA BICA FIXA
BASE PARA PAREDE



Código	Acab.	Abertura	Material
28321	C23	MVS	Metal/Copo ABS
9927	C31	MVS	Metal/Copo ABS
17256	C33	MVS	Metal/Copo ABS
17257	C40	MVS	Metal/Copo ABS
17259	C50	MVS	Metal/Copo ABS
7065	C52	MVS	Metal/Copo ABS
28315	C17	1/4 Volta	Metal/Copo ABS
20791	C31	1/4 Volta	Metal/Copo ABS
20790	C33	1/4 Volta	Metal/Copo ABS
28323	C38	1/4 Volta	Metal/Copo ABS
28324	C39	1/4 Volta	Metal/Copo ABS
20789	C40	1/4 Volta	Metal/Copo ABS
20787	C50	1/4 Volta	Metal/Copo ABS
28325	C52	1/4 Volta	Metal/Copo ABS
28326	C55	1/4 Volta	Metal/Copo ABS
28327	C70	1/4 Volta	Metal/Copo ABS
28458	C90	1/4 Volta	Metal/Copo ABS



Cozinha
1167 | METAL

TORNEIRA BICA ALTA E MÓVEL
BASE PARA PAREDE



DICAS DE USO
E MANUTENÇÃO



Código	Acab.	Abertura	Material
7632	C23	MVS	Metal
7671	C31	MVS	Metal
7638	C33	MVS	Metal
7644	C40	MVS	Metal
7653	C50	MVS	Metal
7668	C52	MVS	Metal
28166	C17	1/4 Volta	Metal
7497	C31	1/4 Volta	Metal
7494	C33	1/4 Volta	Metal
25797	C38	1/4 Volta	Metal
25798	C39	1/4 Volta	Metal
7500	C40	1/4 Volta	Metal
7509	C50	1/4 Volta	Metal
7512	C52	1/4 Volta	Metal
25794	C55	1/4 Volta	Metal
20703	C70	1/4 Volta	Metal
21008	C90	1/4 Volta	Metal
27244	CLINIC	1/4 Volta	Metal



Cozinha
1167 | MISTA

TORNEIRA BICA ALTA E MÓVEL
BASE PARA PAREDE



Código	Acab.	Abertura	Material
11497	C23	MVS	Metal/Bica e Acab ABS
9871	C31	MVS	Metal/Bica e Acab ABS
7641	C33	MVS	Metal/Bica e Acab ABS
11709	C40	MVS	Metal/Bica e Acab ABS
7665	C50	MVS	Metal/Bica e Acab ABS
18351	C23	1/4 Volta	Metal/Bica e Acab ABS
18353	C31	1/4 Volta	Metal/Bica e Acab ABS
18354	C33	1/4 Volta	Metal/Bica e Acab ABS
20563	C40	1/4 Volta	Metal/Bica e Acab ABS
20564	C50	1/4 Volta	Metal/Bica e Acab ABS
15645	C70	1/4 Volta	Metal/Bica e Acab ABS



Cozinha
1167 | GOURMET - 5/8

TORNEIRA BICA FLEXÍVEL
BASE PARA PAREDE



Código	Acab.	Abertura	Material
28460	C17	1/4 Volta	Metal/Gourmet 5/8
28459	C70	1/4 Volta	Metal/Gourmet 5/8

Cozinha
1168 | METAL

TORNEIRA BICA ALTA E MÓVEL
BASE PARA **BANCADA**



Código	Acab.	Abertura	Material
6789	C23	MVS	Metal
6762	C31	MVS	Metal
6795	C33	MVS	Metal
6801	C40	MVS	Metal
6810	C50	MVS	Metal
6813	C52	MVS	Metal
28172	C17	1/4 Volta	Metal
18357	C31	1/4 Volta	Metal
18359	C33	1/4 Volta	Metal
25801	C38	1/4 Volta	Metal
25802	C39	1/4 Volta	Metal
14244	C40	1/4 Volta	Metal
14261	C50	1/4 Volta	Metal
17293	C52	1/4 Volta	Metal
25800	C55	1/4 Volta	Metal
20704	C70	1/4 Volta	Metal
21010	C90	1/4 Volta	Metal

DICAS DE USO
E MANUTENÇÃO



Cozinha
1168 | MISTA

TORNEIRA BICA FLEXÍVEL
BASE PARA **BANCADA**



Código	Acab.	Abertura	Material
12014	C23	MVS	Metal/Bica e Acab ABS
9720	C31	MVS	Metal/Bica e Acab ABS
6798	C33	MVS	Metal/Bica e Acab ABS
12019	C40	MVS	Metal/Bica e Acab ABS
6930	C50	MVS	Metal/Bica e Acab ABS
18356	C23	1/4 Volta	Metal/Bica e Acab ABS
18358	C31	1/4 Volta	Metal/Bica e Acab ABS
18361	C33	1/4 Volta	Metal/Bica e Acab ABS
20565	C40	1/4 Volta	Metal/Bica e Acab ABS
20566	C50	1/4 Volta	Metal/Bica e Acab ABS
11227	C70	1/4 Volta	Metal/Bica e Acab ABS

DICAS DE USO
E MANUTENÇÃO



Cozinha
1168 | GOURMET - 5/8

TORNEIRA BICA ALTA E MÓVEL
BASE PARA **BANCADA**



Código	Acab.	Abertura	Material
28462	C17	1/4 Volta	Metal/Gourmet 5/8
28461	C70	1/4 Volta	Metal/Gourmet 5/8

Cozinha
1167 | METAL | BICA BAIXA

TORNEIRA BICA BAIXA E MÓVEL
BASE PARA PAREDE



C17



C23



C31



C33



C38



C39



C40



C50



C52



C55



C70



C90

Código	Acab.	Abertura	Material
7707	C23	MVS	Metal
7737	C31	MVS	Metal
7713	C33	MVS	Metal
7719	C40	MVS	Metal
7728	C50	MVS	Metal
7734	C52	MVS	Metal
28170	C17	1/4 Volta	Metal
18722	C31	1/4 Volta	Metal
18727	C33	1/4 Volta	Metal
28167	C38	1/4 Volta	Metal
28168	C39	1/4 Volta	Metal
25649	C40	1/4 Volta	Metal
17952	C50	1/4 Volta	Metal
18731	C52	1/4 Volta	Metal
28169	C55	1/4 Volta	Metal
28171	C70	1/4 Volta	Metal
21009	C90	1/4 Volta	Metal

12 ANOS GARANTIA
 SACO PLÁSTICO
6 CAIXA FECHADA
 1/4 MVS
 15686 6299

Cozinha
1168 | METAL | BICA BAIXA

TORNEIRA BICA BAIXA E MÓVEL
BASE PARA **BANCADA**



C17



C23



C31



C33



C38



C39



C40



C50



C52



C55



C70



C90



Código	Acab.	Abertura	Material
6840	C23	MVS	Metal
6852	C31	MVS	Metal
6846	C33	MVS	Metal
6855	C40	MVS	Metal
6867	C50	MVS	Metal
6873	C52	MVS	Metal
28173	C17	1/4 Volta	Metal
18737	C31	1/4 Volta	Metal
18743	C33	1/4 Volta	Metal
28174	C38	1/4 Volta	Metal
28175	C39	1/4 Volta	Metal
28176	C40	1/4 Volta	Metal
28177	C50	1/4 Volta	Metal
18752	C52	1/4 Volta	Metal
29240	C55	1/4 Volta	Metal
28178	C70	1/4 Volta	Metal
21011	C90	1/4 Volta	Metal



Cozinha
1567 | CREE

TORNEIRA FIXA
BASE PARA **PAREDE**



Código	Acab.	Variação	Material
8679	CREE	1/4 Volta	Metal



Cozinha
1150 | METAL

TORNEIRA BICA FIXA
BASE PARA PAREDE



C17



C23



C31



C33

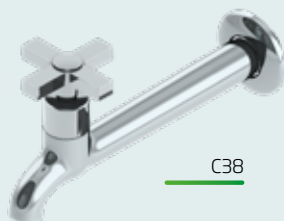

C38



C39



C40



C50



C55

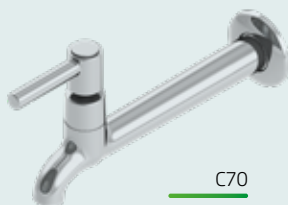

C70



C90

Código	Acab.	Abertura	Material
13450	C23	MVS	Metal
28185	C31	MVS	Metal
13470	C33	MVS	Metal
16350	C40	MVS	Metal
14159	C50	MVS	Metal
28180	C17	1/4 Volta	Metal
18490	C23	1/4 Volta	Metal
28186	C31	1/4 Volta	Metal
18497	C33	1/4 Volta	Metal
28181	C38	1/4 Volta	Metal
28182	C39	1/4 Volta	Metal
17285	C40	1/4 Volta	Metal
20802	C50	1/4 Volta	Metal
28183	C55	1/4 Volta	Metal
28184	C70	1/4 Volta	Metal
21018	C90	1/4 Volta	Metal

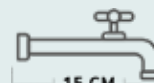

Cozinha
1150 | MISTA

TORNEIRA BICA FIXA
BASE PARA PAREDE



C23

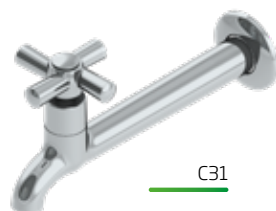

C31



C33



C40



C50

Código	Acab.	Abertura	Material
11978	C23	MVS	Metal/Acab ABS
28187	C31	MVS	Metal/Acab ABS
11984	C33	MVS	Metal/Acab ABS
20801	C40	MVS	Metal/Acab ABS
11987	C50	MVS	Metal/Acab ABS



Cozinha
1158 | METAL

TORNEIRA BICA FIXA
BASE PARA PAREDE

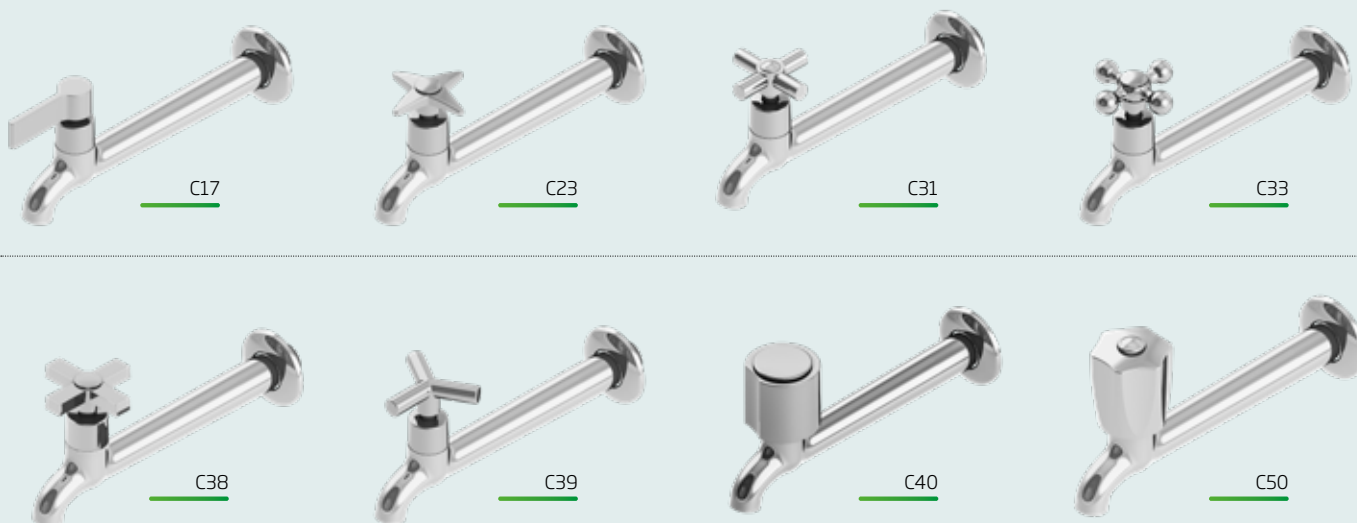

Código	Acab.	Abertura	Material
7344	C23	MVS	Metal
7371	C31	MVS	Metal
7350	C33	MVS	Metal
15688	C40	MVS	Metal
7362	C50	MVS	Metal
7377	C17	1/4 Volta	Metal
18500	C23	1/4 Volta	Metal
18560	C31	1/4 Volta	Metal
18583	C33	1/4 Volta	Metal
7374	C38	1/4 Volta	Metal
7356	C39	1/4 Volta	Metal
20803	C40	1/4 Volta	Metal
20804	C50	1/4 Volta	Metal
7368	C55	1/4 Volta	Metal
7317	C70	1/4 Volta	Metal
21019	C90	1/4 Volta	Metal

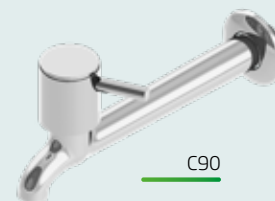
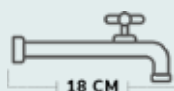
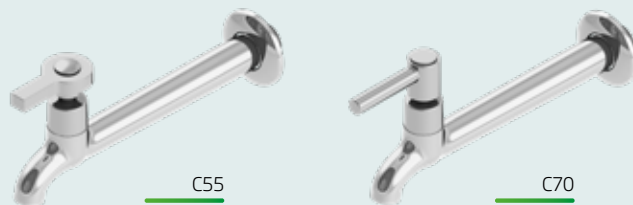

Cozinha
1158 | MISTA

TORNEIRA BICA FIXA
BASE PARA PAREDE



Código	Acab.	Abertura	Material
7347	C23	MVS	Metal/Acab ABS
11682	C31	MVS	Metal/Acab ABS
7353	C33	MVS	Metal/Acab ABS
17284	C40	MVS	Metal/Acab ABS
7365	C50	MVS	Metal/Acab ABS

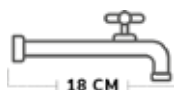

Cozinha
1158 | METAL C/ AREJADOR

TORNEIRA BICA FIXA
BASE PARA PAREDE



Código	Acab.	Abertura	Material
7263	C23	MVS	Metal
7284	C31	MVS	Metal
7269	C33	MVS	Metal
17283	C40	MVS	Metal
7278	C50	MVS	Metal
7275	C17	1/4 Volta	Metal
18607	C23	1/4 Volta	Metal
18621	C31	1/4 Volta	Metal
18625	C33	1/4 Volta	Metal
9491	C38	1/4 Volta	Metal
28188	C39	1/4 Volta	Metal
28189	C40	1/4 Volta	Metal
28190	C50	1/4 Volta	Metal
28191	C55	1/4 Volta	Metal
24401	C70	1/4 Volta	Metal
21111	C90	1/4 Volta	Metal

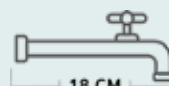
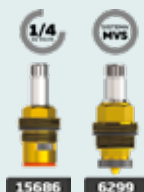

Cozinha
1158 | MISTA C/ AREJADOR

TORNEIRA BICA FIXA
BASE PARA PAREDE



Código	Acab.	Abertura	Material
7266	C23	MVS	Metal/Acab ABS
11683	C31	MVS	Metal/Acab ABS
7272	C33	MVS	Metal/Acab ABS
17963	C40	MVS	Metal/Acab ABS
7281	C50	MVS	Metal/Acab ABS



Cozinha
1158 | METAL C/ BICO

TORNEIRA BICA FIXA
BASE PARA PAREDE



Código	Acab.	Abertura	Material
7287	C23	MVS	Metal
7341	C31	MVS	Metal
7293	C33	MVS	Metal
28199	C40	MVS	Metal
7323	C50	MVS	Metal
28193	C17	1/4 Volta	Metal
18588	C23	1/4 Volta	Metal
18594	C31	1/4 Volta	Metal
18600	C33	1/4 Volta	Metal
28194	C38	1/4 Volta	Metal
28195	C39	1/4 Volta	Metal
28196	C40	1/4 Volta	Metal
28197	C50	1/4 Volta	Metal
28198	C55	1/4 Volta	Metal
24402	C70	1/4 Volta	Metal
21112	C90	1/4 Volta	Metal



Cozinha
1158 | MISTA C/ BICO

TORNEIRA BICA FIXA
BASE PARA PAREDE



Código	Acab.	Abertura	Material
7290	C23	MVS	Metal/Acab ABS
11684	C31	MVS	Metal/Acab ABS
7314	C33	MVS	Metal/Acab ABS
28192	C40	MVS	Metal/Acab ABS
7326	C50	MVS	Metal/Acab ABS

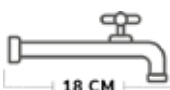

Cozinha
1159 | METAL

TORNEIRA BICA FIXA
BASE PARA PAREDE

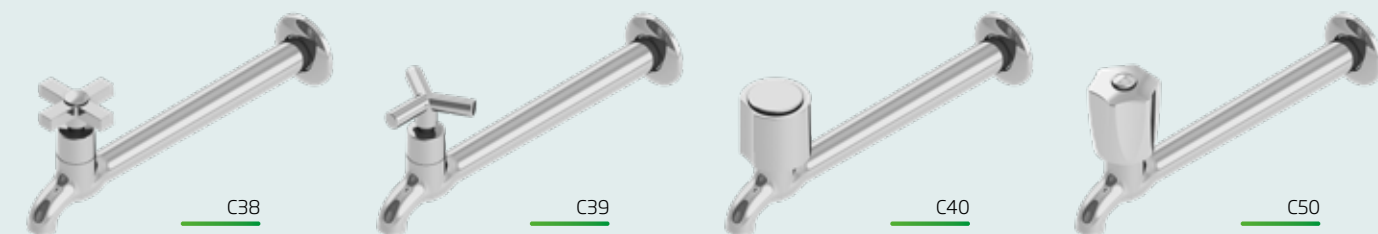
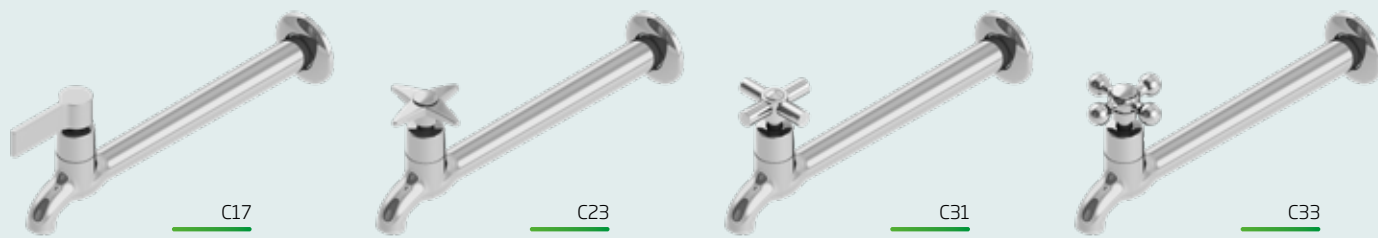

Código	Acab.	Abertura	Material
7455	C23	MVS	Metal
7485	C31	MVS	Metal
7461	C33	MVS	Metal
16103	C40	MVS	Metal
7476	C50	MVS	Metal
28200	C17	1/4 Volta	Metal
18629	C23	1/4 Volta	Metal
18631	C31	1/4 Volta	Metal
18634	C33	1/4 Volta	Metal
28201	C38	1/4 Volta	Metal
28202	C39	1/4 Volta	Metal
28203	C40	1/4 Volta	Metal
28204	C50	1/4 Volta	Metal
28205	C55	1/4 Volta	Metal
28206	C70	1/4 Volta	Metal
21020	C90	1/4 Volta	Metal

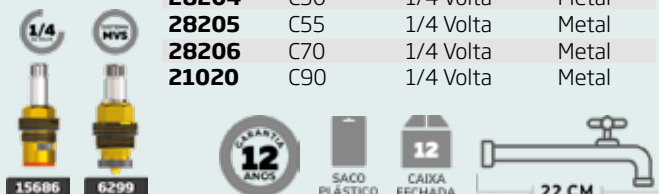

Cozinha
1159 | MISTA

TORNEIRA BICA FIXA
BASE PARA PAREDE



Código	Acab.	Abertura	Material
7458	C23	MVS	Metal/Acab ABS
11697	C31	MVS	Metal/Acab ABS
7464	C33	MVS	Metal/Acab ABS
7470	C40	MVS	Metal/Acab ABS
7479	C50	MVS	Metal/Acab ABS

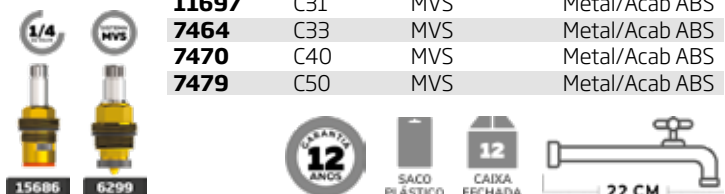

Cozinha
1159 | METAL C/ AREJADOR

TORNEIRA BICA FIXA
BASE PARA PAREDE



Código	Acab.	Abertura	Material
7386	C23	MVS	Metal
7413	C31	MVS	Metal
7392	C33	MVS	Metal
7398	C40	MVS	Metal
7404	C50	MVS	Metal
28207	C17	1/4 Volta	Metal
18686	C23	1/4 Volta	Metal
18690	C31	1/4 Volta	Metal
18707	C33	1/4 Volta	Metal
28208	C38	1/4 Volta	Metal
28209	C39	1/4 Volta	Metal
28210	C40	1/4 Volta	Metal
7410	C50	1/4 Volta	Metal
28211	C55	1/4 Volta	Metal
7473	C70	1/4 Volta	Metal
21113	C90	1/4 Volta	Metal



Cozinha
1159 | MISTA C/ AREJADOR

TORNEIRA BICA FIXA
BASE PARA PAREDE



Código	Acab.	Abertura	Material
7389	C23	MVS	Metal/Acab ABS
11694	C31	MVS	Metal/Acab ABS
7395	C33	MVS	Metal/Acab ABS
7488	C40	MVS	Metal/Acab ABS
7407	C50	MVS	Metal/Acab ABS

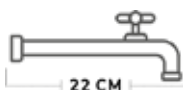

Cozinha
1159 | METAL C/ BICO

TORNEIRA BICA FIXA
BASE PARA PAREDE

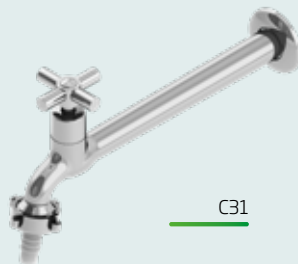
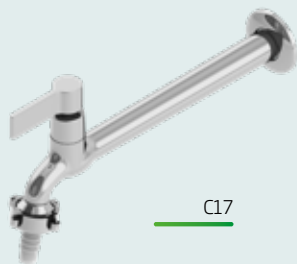

Código	Acab.	Abertura	Material
7416	C23	MVS	Metal
7452	C31	MVS	Metal
7422	C33	MVS	Metal
28212	C40	MVS	Metal
7434	C50	MVS	Metal
28213	C17	1/4 Volta	Metal
18642	C23	1/4 Volta	Metal
18661	C31	1/4 Volta	Metal
18681	C33	1/4 Volta	Metal
28214	C38	1/4 Volta	Metal
28215	C39	1/4 Volta	Metal
28216	C40	1/4 Volta	Metal
28217	C50	1/4 Volta	Metal
28218	C55	1/4 Volta	Metal
24399	C70	1/4 Volta	Metal
21114	C90	1/4 Volta	Metal

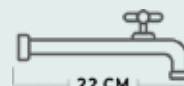

Cozinha
1159 | MISTA C/ BICO

TORNEIRA BICA FIXA
BASE PARA PAREDE



Código	Acab.	Abertura	Material
7419	C23	MVS	Metal/Acab ABS
11700	C31	MVS	Metal/Acab ABS
7425	C33	MVS	Metal/Acab ABS
28219	C40	MVS	Metal/Acab ABS
7437	C50	MVS	Metal/Acab ABS



Lavatório 1198 | METAL

TORNEIRA BICA MÓVEL
BASE PARA **BANCADA**



C17



C23



C31



C33



C38



C39



C40



C50

Código	Acab.	Abertura	Material
8253	C23	MVS	Metal
8265	C31	MVS	Metal
8259	C33	MVS	Metal
8268	C40	MVS	Metal
8280	C50	MVS	Metal
8286	C52	MVS	Metal
28179	C17	1/4 Volta	Metal
18394	C31	1/4 Volta	Metal
18398	C33	1/4 Volta	Metal
26562	C38	1/4 Volta	Metal
25852	C39	1/4 Volta	Metal
14240	C40	1/4 Volta	Metal
14257	C50	1/4 Volta	Metal
8196	C52	1/4 Volta	Metal
25853	C55	1/4 Volta	Metal
20705	C70	1/4 Volta	Metal
21006	C90	1/4 Volta	Metal



C52



C55



C70



C90

Lavatório 1198 | MISTA

TORNEIRA BICA MÓVEL
BASE PARA **BANCADA**



C23



C31



C33



C40



C50

Código	Acab.	Abertura	Material
11661	C23	MVS	Metal/Bica e Acab ABS
6248	C31	MVS	Metal/Bica e Acab ABS
8262	C33	MVS	Metal/Bica e Acab ABS
11666	C40	MVS	Metal/Bica e Acab ABS
8283	C50	MVS	Metal/Bica e Acab ABS
18393	C23	1/4 Volta	Metal/Bica e Acab ABS
18395	C31	1/4 Volta	Metal/Bica e Acab ABS
18399	C33	1/4 Volta	Metal/Bica e Acab ABS
20567	C40	1/4 Volta	Metal/Bica e Acab ABS
20568	C50	1/4 Volta	Metal/Bica e Acab ABS
14302	C70	1/4 Volta	Metal/Bica e Acab ABS



C70

Lavatório 1194 | METAL

TORNEIRA FIXA
BASE PARA **BANCADA**

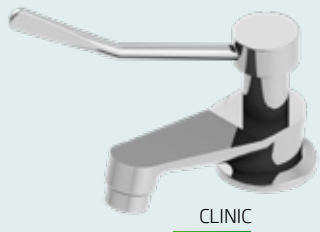
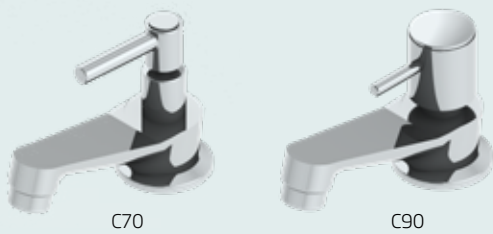

Código	Acab.	Abertura	Material
7980	C23	MVS	Metal
7992	C31	MVS	Metal
7983	C33	MVS	Metal
7995	C40	MVS	Metal
8007	C50	MVS	Metal
8013	C52	MVS	Metal
28221	C17	1/4 Volta	Metal
18362	C31	1/4 Volta	Metal
18364	C33	1/4 Volta	Metal
28222	C38	1/4 Volta	Metal
28223	C39	1/4 Volta	Metal
14253	C40	1/4 Volta	Metal
14270	C50	1/4 Volta	Metal
18387	C52	1/4 Volta	Metal
28224	C55	1/4 Volta	Metal
28225	C70	1/4 Volta	Metal
21012	C90	1/4 Volta	Metal
27243	CLINIC	1/4 Volta	Metal



Código	Acab.	Abertura	Material
8019	C23	MVS	Metal/Acab ABS
6245	C31	MVS	Metal/Acab ABS
7986	C33	MVS	Metal/Acab ABS
11657	C40	MVS	Metal/Acab ABS
8010	C50	MVS	Metal/Acab ABS

Lavatório 1193 | METAL

TORNEIRA FIXA
BASE PARA **BANCADA**



C17



C23



C31



C33



C38



C39



C40



C50

Código	Acab.	Abertura	Material
7953	C23	MVS	Metal
6177	C31	MVS	Metal
7959	C33	MVS	Metal
16366	C40	MVS	Metal
7974	C50	MVS	Metal
28436	C17	1/4 Volta	Metal
28437	C31	1/4 Volta	Metal
28438	C33	1/4 Volta	Metal
28439	C38	1/4 Volta	Metal
28440	C39	1/4 Volta	Metal
20805	C40	1/4 Volta	Metal
28441	C50	1/4 Volta	Metal
28442	C55	1/4 Volta	Metal
28443	C70	1/4 Volta	Metal
28444	C90	1/4 Volta	Metal



C55



C70



C90

Lavatório 1193 | MISTA

TORNEIRA FIXA
BASE PARA **BANCADA**



C23



C31



C33



C40

Código	Acab.	Abertura	Material
7956	C23	MVS	Metal/Acab ABS
6179	C31	MVS	Metal/Acab ABS
7962	C33	MVS	Metal/Acab ABS
7968	C40	MVS	Metal/Acab ABS
7977	C50	MVS	Metal/Acab ABS



C50

Ducha Higiênica 1739 | METAL

Código	Acab.	Abertura	Material
28330	C23	MVS	Metal
4830	C31	MVS	Metal
4833	C33	MVS	Metal
4839	C40	MVS	Metal
4853	C50	MVS	Metal
4859	C52	MVS	Metal
28331	C17	1/4 Volta	Metal
20810	C31	1/4 Volta	Metal
20811	C33	1/4 Volta	Metal
26566	C38	1/4 Volta	Metal
28332	C39	1/4 Volta	Metal
14304	C40	1/4 Volta	Metal
14303	C50	1/4 Volta	Metal
25799	C52	1/4 Volta	Metal
26567	C55	1/4 Volta	Metal
20683	C70	1/4 Volta	Metal
21024	C90	1/4 Volta	Metal

Ducha Higiênica 1739 | MISTA

Código	Acab.	Abertura	Material
28329	C23	MVS	Metal/Gatilho e Acab ABS
9150	C31	MVS	Metal/Gatilho e Acab ABS
4836	C33	MVS	Metal/Gatilho e Acab ABS
20551	C40	MVS	Metal/Gatilho e Acab ABS
4856	C50	MVS	Metal/Gatilho e Acab ABS
28328	C23	1/4 Volta	Metal/Gatilho e Acab ABS
20549	C31	1/4 Volta	Metal/Gatilho e Acab ABS
20548	C33	1/4 Volta	Metal/Gatilho e Acab ABS
9252	C40	1/4 Volta	Metal/Gatilho e Acab ABS
20552	C50	1/4 Volta	Metal/Gatilho e Acab ABS
15347	C70	1/4 Volta	Metal/Gatilho e Acab ABS

Ducha Higiênica c/ Desviador 1740 | METAL



Código	Acab.	Abertura	Material
28333	C17	1/4 Volta	Metal
21212	C31	1/4 Volta	Metal
21214	C33	1/4 Volta	Metal
28334	C38	1/4 Volta	Metal
28335	C39	1/4 Volta	Metal
21216	C40	1/4 Volta	Metal
21218	C50	1/4 Volta	Metal
21219	C52	1/4 Volta	Metal
28336	C55	1/4 Volta	Metal
28337	C70	1/4 Volta	Metal
21233	C90	1/4 Volta	Metal



Ducha Higiênica c/ Desviador 1740 | MISTA

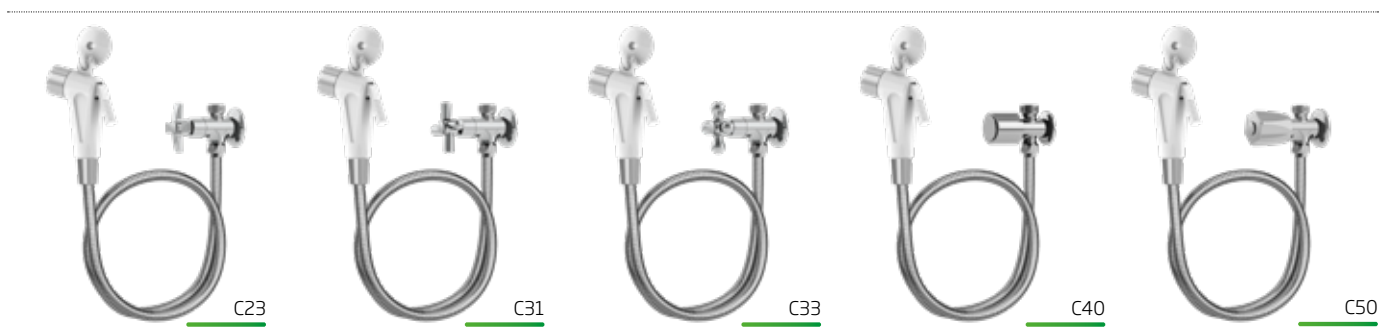

Código	Acab.	Abertura	Material
28338	C23	1/4 Volta	Metal/Gatilho e Acab ABS
21210	C31	1/4 Volta	Metal/Gatilho e Acab ABS
21213	C33	1/4 Volta	Metal/Gatilho e Acab ABS
21215	C40	1/4 Volta	Metal/Gatilho e Acab ABS
21217	C50	1/4 Volta	Metal/Gatilho e Acab ABS
28339	C70	1/4 Volta	Metal/Gatilho e Acab ABS



Ducha Higiênica 1739 | REPOSIÇÃO

Código	Acab.	Abertura	Material
28340	C17	1/4 Volta	Metal
21268	C31	1/4 Volta	Metal
21269	C33	1/4 Volta	Metal
28341	C38	1/4 Volta	Metal
28342	C39	1/4 Volta	Metal
21270	C40	1/4 Volta	Metal
21271	C50	1/4 Volta	Metal
28343	C52	1/4 Volta	Metal
28344	C55	1/4 Volta	Metal
28345	C70	1/4 Volta	Metal
21324	C90	1/4 Volta	Metal

Ducha Higiênica 1740 | REPOSIÇÃO

Código	Acab.	Abertura	Material
28346	C17	1/4 Volta	Metal
21296	C31	1/4 Volta	Metal
21299	C33	1/4 Volta	Metal
28347	C38	1/4 Volta	Metal
28348	C39	1/4 Volta	Metal
21301	C40	1/4 Volta	Metal
21305	C50	1/4 Volta	Metal
28349	C52	1/4 Volta	Metal
28350	C55	1/4 Volta	Metal
28351	C70	1/4 Volta	Metal
21323	C90	1/4 Volta	Metal

Máquina de Lavar 1420 | METAL

Código	Acab.	Abertura	Material
7188	C23	MVS	Metal
7218	C31	MVS	Metal
7194	C33	MVS	Metal
7200	C40	MVS	Metal
7209	C50	MVS	Metal

Máquina de Lavar 1428 | METAL C/ BICO

TORNEIRA FIXA
BASE PARA PAREDE



C17



C23



C31



C33



C38



C39



C40



C50



C52



C55

Código	Acab.	Abertura	Material
7224	C23	MVS	Metal
7230	C31	MVS	Metal
7233	C33	MVS	Metal
9907	C40	MVS	Metal
7248	C50	MVS	Metal
28355	C17	1/4 Volta	Metal
18426	C31	1/4 Volta	Metal
18428	C33	1/4 Volta	Metal
27287	C38	1/4 Volta	Metal
28356	C39	1/4 Volta	Metal
28357	C40	1/4 Volta	Metal
20809	C50	1/4 Volta	Metal
28358	C55	1/4 Volta	Metal
20808	C70	1/4 Volta	Metal
21013	C90	1/4 Volta	Metal



C70



C90

Máquina de Lavar 1428 | MISTA C/ BICO



C23



C31



C33



C40



C50

Código	Acab.	Abertura	Material
7227	C23	MVS	Metal/Acab ABS
7257	C31	MVS	Metal/Acab ABS
7236	C33	MVS	Metal/Acab ABS
7242	C40	MVS	Metal/Acab ABS
7251	C50	MVS	Metal/Acab ABS
28352	C23	1/4 Volta	Metal/Acab ABS
18427	C31	1/4 Volta	Metal/Acab ABS
18430	C33	1/4 Volta	Metal/Acab ABS
17044	C40	1/4 Volta	Metal/Acab ABS
28353	C50	1/4 Volta	Metal/Acab ABS
28354	C70	1/4 Volta	Metal/Acab ABS



C70

Tanque 1126 | METAL

TORNEIRA FIXA
BASE PARA PAREDE

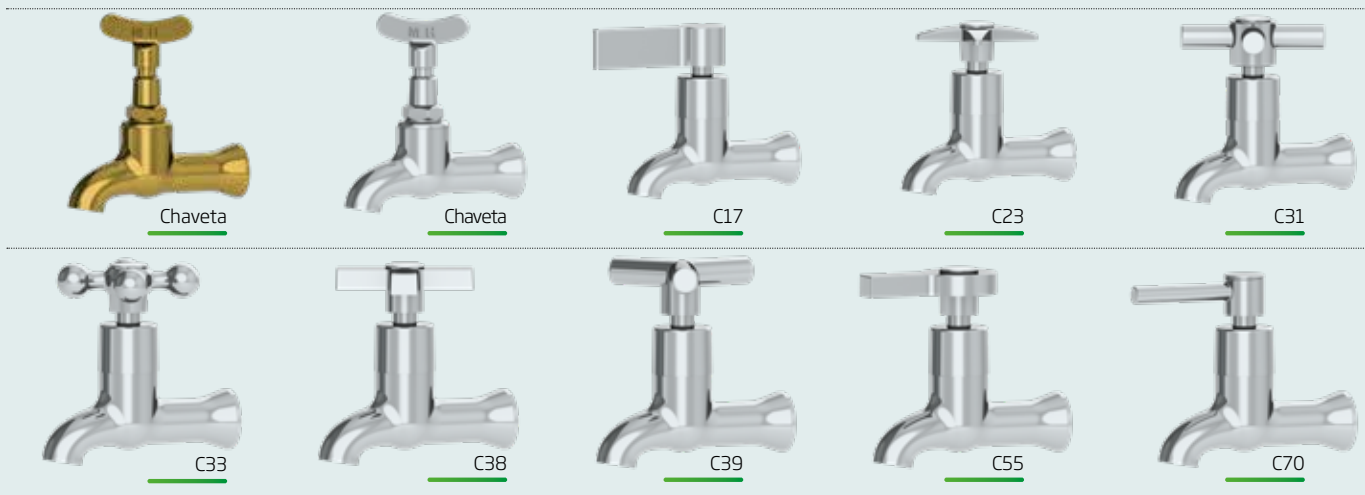

Código	Acab.	Variação	Abertura	Material
8451	Chaveta	1/2 X 1/2	SV	Metal Amarelo
8457	Chaveta	1/2 X 1/2	SV	Metal
8466	C23	1/2 X 1/2	SV	Metal
28365	C31	1/2 X 1/2	SV	Metal
8469	C33	1/2 X 1/2	SV	Metal
28367	C17	1/2 X 1/2	1/4 Volta	Metal
28368	C31	1/2 X 1/2	1/4 Volta	Metal
28369	C33	1/2 X 1/2	1/4 Volta	Metal
28371	C38	1/2 X 1/2	1/4 Volta	Metal
28372	C39	1/2 X 1/2	1/4 Volta	Metal
28373	C55	1/2 X 1/2	1/4 Volta	Metal
28374	C70	1/2 X 1/2	1/4 Volta	Metal



tanque 1126 | MISTA

TORNEIRA FIXA
BASE PARA PAREDE



Código	Acab.	Variação	Abertura	Material
8478	C23	1/2 X 1/2	SV	Metal/Acab ABS
28375	C31	1/2 X 1/2	SV	Metal/Acab ABS
8481	C33	1/2 X 1/2	SV	Metal/Acab ABS
28376	C70	1/2 X 1/2	1/4 Volta	Metal/Acab ABS



Jardim 1128 | METAL

TORNEIRA FIXA
BASE PARA PAREDE

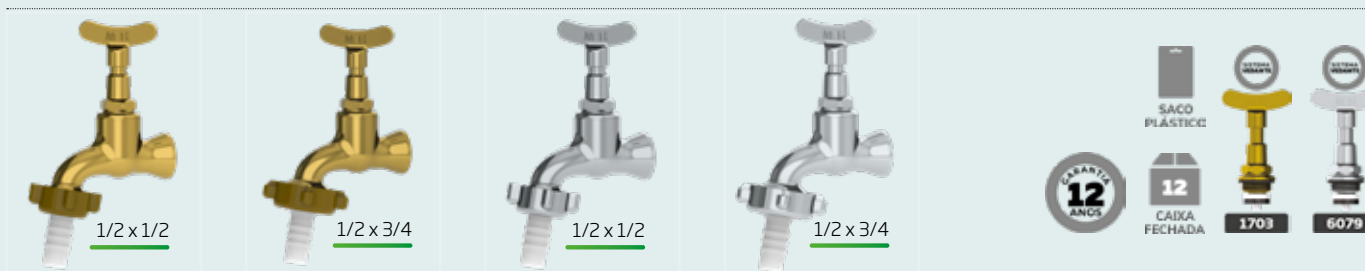

Código	Acab.	Variação	Abertura	Material
8538	Chaveta	1/2 X 1/2	SV	Metal Amarelo
8541	Chaveta	1/2 X 3/4	SV	Metal Amarelo
8544	Chaveta	3/4 X 3/4	SV	Metal Amarelo
8547	Chaveta	1/2 X 1/2	SV	Metal
8574	Chaveta	1/2 X 3/4	SV	Metal
8550	Chaveta	3/4 X 3/4	SV	Metal



Jardim
1130 | METAL

TORNEIRA FIXA
BASE PARA PAREDE

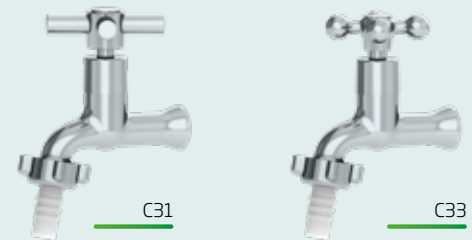
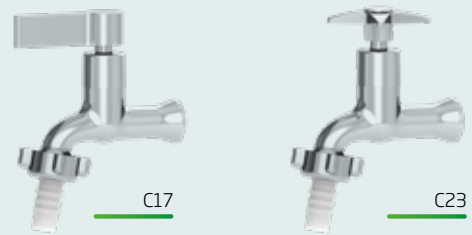
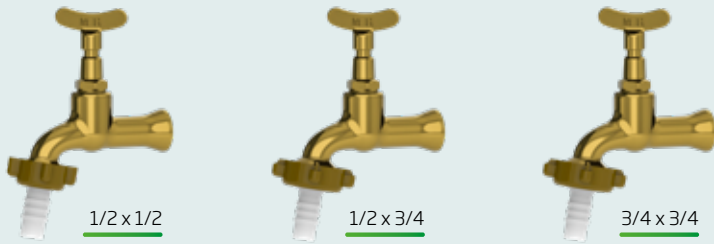

Código	Acab.	Variação	Abertura	Material
8619	Chaveta	1/2 X 1/2	SV	Metal Amarelo
11536	Chaveta	1/2 X 3/4	SV	Metal Amarelo
8622	Chaveta	3/4 X 3/4	SV	Metal Amarelo
8625	Chaveta	1/2 X 1/2	SV	Metal
10406	Chaveta	1/2 X 3/4	SV	Metal
8628	Chaveta	3/4 X 3/4	SV	Metal
8631	C23	1/2 X 1/2	SV	Metal
16533	C23	1/2 X 3/4	SV	Metal
17104	C31	1/2 X 1/2	SV	Metal
21239	C31	1/2 X 3/4	SV	Metal
8637	C33	1/2 X 1/2	SV	Metal
16534	C33	1/2 X 3/4	SV	Metal
28359	C17	1/2 X 3/4	1/4 Volta	Metal
27473	C31	1/2 X 3/4	1/4 Volta	Metal
28360	C33	1/2 X 3/4	1/4 Volta	Metal
5794	C38	1/2 X 3/4	1/4 Volta	Metal
28361	C39	1/2 X 3/4	1/4 Volta	Metal
28362	C55	1/2 X 3/4	1/4 Volta	Metal
28119	C70	1/2 X 3/4	1/4 Volta	Metal



Jardim
1130 | MISTA

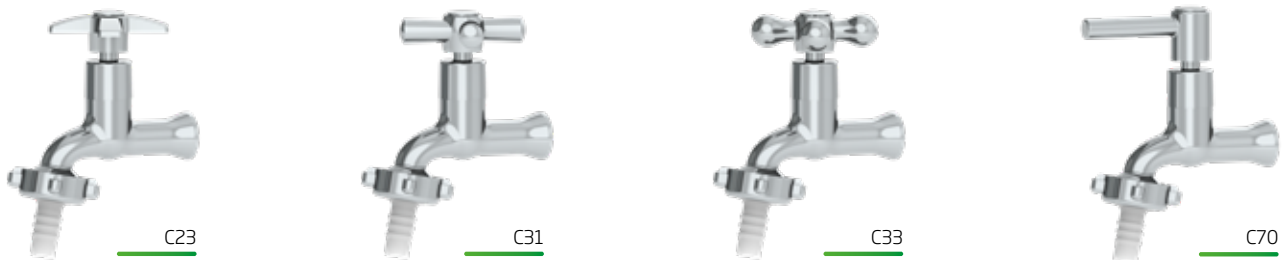

Código	Acab.	Variação	Abertura	Material
13477	C23	1/2 X 3/4	SV	Metal/Acab ABS
21242	C31	1/2 X 3/4	SV	Metal/Acab ABS
13481	C33	1/2 X 3/4	SV	Metal/Acab ABS
28364	C70	1/2 X 3/4	1/4 Volta	Metal/Acab ABS



REGISTRO DE GAVETA

1509 | 1 | METAL



Código	Acab.	Variação	Material
4673	C23	1	Metal
4679	C31	1	Metal
4708	C33	1	Metal
28398	C38	1	Metal
28399	C39	1	Metal
4682	C40	1	Metal
4697	C50	1	Metal
4705	C52	1	Metal



1509 | 1.1/2 | METAL



Código	Acab.	Variação	Material
4764	C23	1.1/2	Metal
4775	C31	1.1/2	Metal
4768	C33	1.1/2	Metal
28393	C38	1.1/2	Metal
28394	C39	1.1/2	Metal
4780	C40	1.1/2	Metal
4794	C50	1.1/2	Metal
4800	C52	1.1/2	Metal



1509 | 1.1/2 | MISTA



Código	Acab.	Variação	Material
28395	C23	1.1/2	Metal/Acab ABS
17314	C31	1.1/2	Metal/Acab ABS
4771	C33	1.1/2	Metal/Acab ABS
16398	C40	1.1/2	Metal/Acab ABS
4797	C50	1.1/2	Metal/Acab ABS

1509 | 1.1/4 | METAL

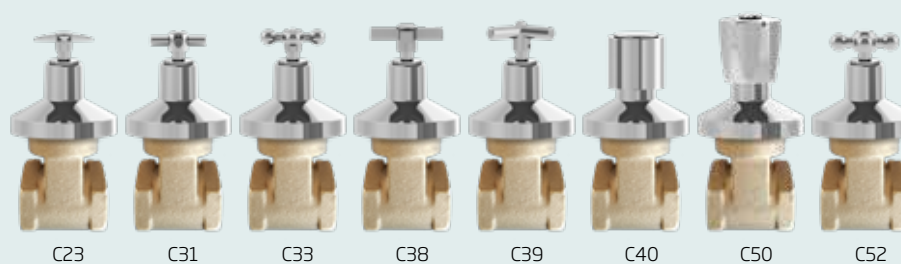

Código	Acab.	Variação	Material
4719	C23	1.1/4	Metal
4732	C31	1.1/4	Metal
4726	C33	1.1/4	Metal
28396	C38	1.1/4	Metal
28397	C39	1.1/4	Metal
4737	C40	1.1/4	Metal
4751	C50	1.1/4	Metal
4757	C52	1.1/4	Metal



1509 | Bruto



Código	Acab.	Variação	Material
4547	Bruto	1/2	Metal
4623	Bruto	3/4	Metal
4670	Bruto	1	Metal
4716	Bruto	1.1/4	Metal
4761	Bruto	1.1/2	Metal
4803	Bruto	2	Metal

REGISTRO DE GAVETA

1509 | 1/2 | METAL



Código	Acab.	Variação	Material
4582	C23	1/2	Metal
4588	C31	1/2	Metal
4591	C33	1/2	Metal
28389	C38	1/2	Metal
28390	C39	1/2	Metal
4598	C40	1/2	Metal
4613	C50	1/2	Metal
4620	C52	1/2	Metal



1509 | 1/2 | MISTA



Código	Acab.	Variação	Material
4585	C23	1/2	Metal/Acab ABS
11627	C31	1/2	Metal/Acab ABS
4594	C33	1/2	Metal/Acab ABS
16397	C40	1/2	Metal/Acab ABS
4617	C50	1/2	Metal/Acab ABS

1509 | 3/4 | METAL



Código	Acab.	Variação	Material
4626	C23	3/4	Metal
4633	C31	3/4	Metal
4637	C33	3/4	Metal
28391	C38	3/4	Metal
28392	C39	3/4	Metal
4644	C40	3/4	Metal
4656	C50	3/4	Metal
4666	C52	3/4	Metal



1509 | 3/4 | MISTA



Código	Acab.	Variação	Material
4629	C23	3/4	Metal/Acab ABS
17315	C31	3/4	Metal/Acab ABS
4641	C33	3/4	Metal/Acab ABS
15411	C40	3/4	Metal/Acab ABS
4662	C50	3/4	Metal/Acab ABS

1509 | Bases



Código	Acab.	Variação	Material
6195	Base	1/2	Metal
6196	Base	3/4	Metal
6199	Base	1	Metal
6198	Base	1.1/4	Metal
6197	Base	1.1/2	Metal
10403	Base	2	Metal

REGISTRO DE PRESSÃO

1400 | 1/2 | METAL

| MISTA



Chaveta

C23

C31

C33



C38

C39

C40

C50

Código	Acab.	Variação	Abertura	Material
6000	Chaveta	1/2	SV	Metal Amarelo
6005	C23	1/2	SV	Metal
26093	C31	1/2	SV	Metal
6020	C33	1/2	SV	Metal
26208	C38	1/2	SV	Metal
26250	C39	1/2	SV	Metal
17306	C40	1/2	SV	Metal
6035	C50	1/2	SV	Metal



C23

C31

C33



C40

C50



6576

12
CAIXA
FECHADA



MISTA

Código	Acab.	Variação	Abertura	Material
6008	C23	1/2	SV	Metal/Acab ABS
26689	C31	1/2	SV	Metal/Acab ABS
6023	C33	1/2	SV	Metal/Acab ABS
6029	C40	1/2	SV	Metal/Acab ABS
6038	C50	1/2	SV	Metal/Acab ABS

1400 | 3/4 | METAL

| MISTA



Chaveta

C23

C31

C33



C38

C39

C40

C50

Código	Acab.	Variação	Abertura	Material
6041	Chaveta	3/4	SV	Metal Amarelo
6044	C23	3/4	SV	Metal
26094	C31	3/4	SV	Metal
5509	C33	3/4	SV	Metal
26209	C38	3/4	SV	Metal
26251	C39	3/4	SV	Metal
17309	C40	3/4	SV	Metal
5557	C50	3/4	SV	Metal



C23

C31

C33



C40

C50

12
CAIXA
FECHADA

12
ANOS



6576

DICAS DE USO
E MANUTENÇÃO



Código	Acab.	Variação	Abertura	Material
6047	C23	3/4	SV	Metal/Acab ABS
26690	C31	3/4	SV	Metal/Acab ABS
5515	C33	3/4	SV	Metal/Acab ABS
5551	C40	3/4	SV	Metal/Acab ABS
5596	C50	3/4	SV	Metal/Acab ABS

REGISTRO DE PRESSÃO

1416 | 1/2 | METAL

| MISTA

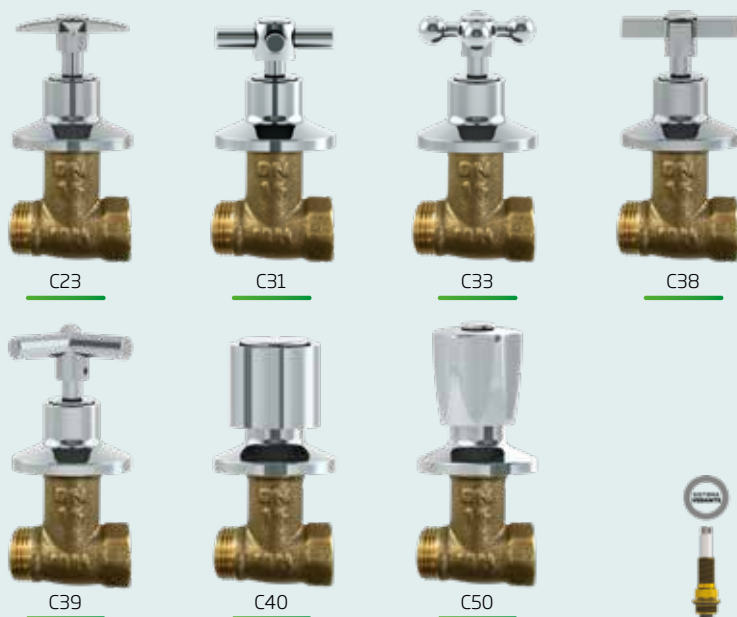

Código	Acab.	Variação	Abertura	Material
6339	C23	1/2	SV	Metal
6345	C31	1/2	SV	Metal
6360	C33	1/2	SV	Metal
26113	C38	1/2	SV	Metal
26116	C39	1/2	SV	Metal
6366	C40	1/2	SV	Metal
6399	C50	1/2	SV	Metal



Código Acab. Variação Abertura Material

6342	C23	1/2	SV	Metal/Acab ABS
12931	C31	1/2	SV	Metal/Acab ABS
6363	C33	1/2	SV	Metal/Acab ABS
17333	C40	1/2	SV	Metal/Acab ABS
6402	C50	1/2	SV	Metal/Acab ABS



1416 | 3/4 | METAL

| MISTA



Código	Acab.	Variação	Abertura	Material
6468	C23	3/4	SV	Metal
6474	C31	3/4	SV	Metal
6477	C33	3/4	SV	Metal
26107	C38	3/4	SV	Metal
26110	C39	3/4	SV	Metal
6483	C40	3/4	SV	Metal
6495	C50	3/4	SV	Metal

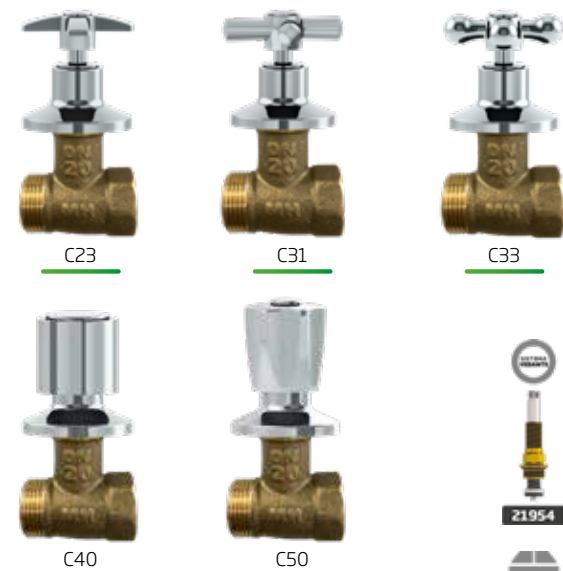

Código Acab. Variação Abertura Material

6471	C23	3/4	SV	Metal/Acab ABS
12933	C31	3/4	SV	Metal/Acab ABS
6480	C33	3/4	SV	Metal/Acab ABS
17313	C40	3/4	SV	Metal/Acab ABS
6498	C50	3/4	SV	Metal/Acab ABS



DICAS DE USO E MANUTENÇÃO



REGISTRO DE PRESSÃO

1416 | 3/4 luxo | 1/4 de volta



C17



C31



C33



C38



C39



C40



C50



C52



C55



C70



Quadra

Código	Acab.	Variação	Abertura	Material
28378	C17	3/4	1/4 Volta	Metal
21069	C31	3/4	1/4 Volta	Metal
21071	C33	3/4	1/4 Volta	Metal
28379	C38	3/4	1/4 Volta	Metal
28380	C39	3/4	1/4 Volta	Metal
21075	C40	3/4	1/4 Volta	Metal
21077	C50	3/4	1/4 Volta	Metal
21079	C52	3/4	1/4 Volta	Metal
28381	C55	3/4	1/4 Volta	Metal
28382	C70	3/4	1/4 Volta	Metal
30715	QUADRA	3/4	1/4 Volta	Metal



1416 | 3/4 luxo



C31



C33



C38



C39



C40



C50



C52

DICAS DE USO E MANUTENÇÃO



Código	Acab.	Variação	Abertura	Material
28383	C31	3/4	SV	Metal
28384	C33	3/4	SV	Metal
28385	C38	3/4	SV	Metal
28386	C39	3/4	SV	Metal
27248	C40	3/4	SV	Metal
27254	C50	3/4	SV	Metal
27260	C52	3/4	SV	Metal

1416 | Bases



1/2



3/4



3/4 Luxo



3/4 Luxo | 1/4 volta

Código	Acab.	Variação	Abertura	Material
6112	Base	1/2	SV	Metal
6194	Base	3/4	SV	Metal
28387	Base Luxo	3/4	SV	Metal
28388	Base Luxo	3/4	1/4 Volta	Metal



KIT SOS COM ACABAMENTO

Metal



Código	Acab.	Variação	Abertura	Material
6594	C23	1/2 ou 3/4	SV	Metal
6624	C31	1/2 ou 3/4	SV	Metal
6600	C33	1/2 ou 3/4	SV	Metal
6606	C40	1/2 ou 3/4	SV	Metal
6618	C50	1/2 ou 3/4	SV	Metal
6627	C52	1/2 ou 3/4	SV	Metal
6191	Sem	1/2 ou 3/4	SV	Metal



Misto

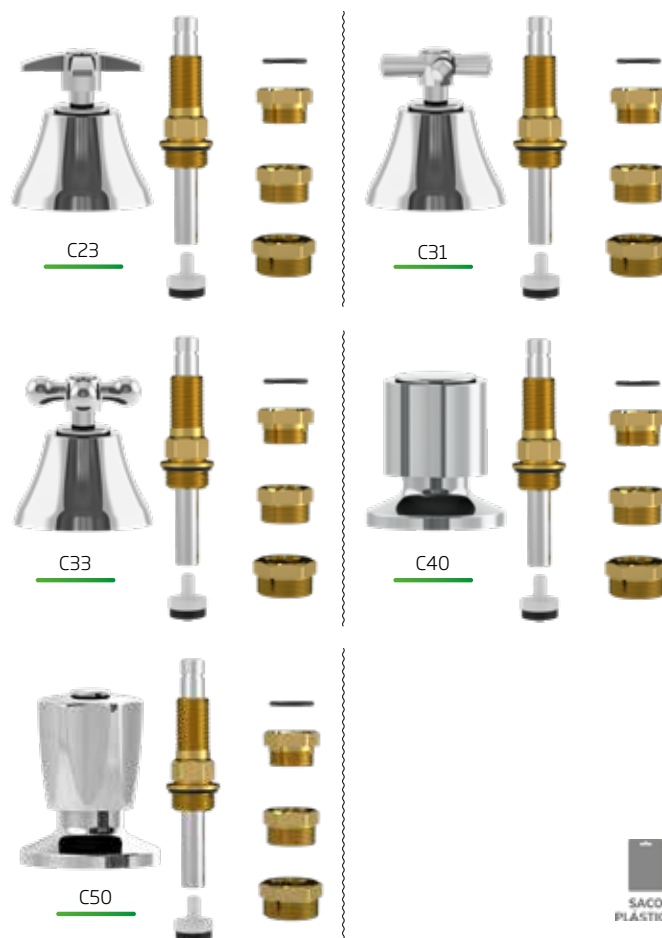

Código	Acab.	Variação	Abertura	Material
6597	C23	1/2 ou 3/4	SV	Metal/ABS
11612	C31	1/2 ou 3/4	SV	Metal/ABS
6603	C33	1/2 ou 3/4	SV	Metal/ABS
11613	C40	1/2 ou 3/4	SV	Metal/ABS
6621	C50	1/2 ou 3/4	SV	Metal/ABS



10x1



Código	Variação	Abertura	Material
23460	Universal	SV ou 1/4	Metal



KIT SALVA REGISTRO

DICAS DE USO E MANUTENÇÃO



KIT SOS 10X1

DICAS DE USO E MANUTENÇÃO



ACABAMENTO

1.1/2

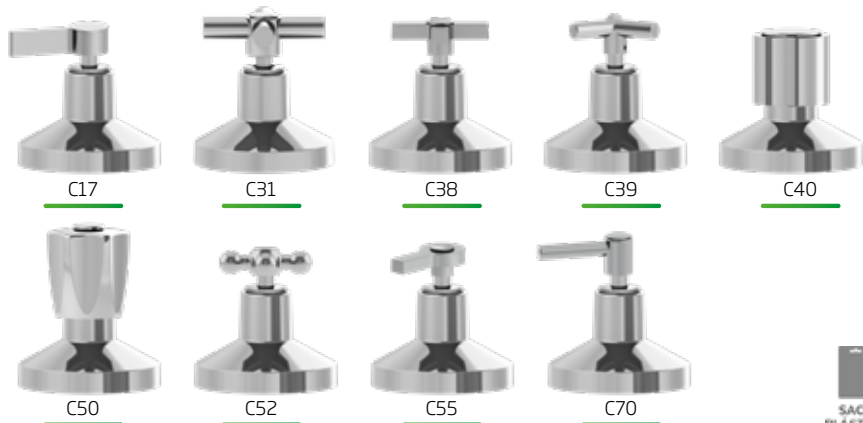

Código	Acab.	Variação	Material
28453	C17	1/4 Volta	Metal
5056	C31	SV ou 1/4 Volta	Metal
5101	C38	SV ou 1/4 Volta	Metal
28454	C39	SV ou 1/4 Volta	Metal
5082	C40	SV ou 1/4 Volta	Metal
5107	C50	SV ou 1/4 Volta	Metal
5120	C52	SV ou 1/4 Volta	Metal
5102	C55	1/4 Volta	Metal
28455	C70	1/4 Volta	Metal



3/4



Código	Acab.	Variação	Material
28451	C17	1/4 Volta	Metal
5045	C23	SV ou 1/4 Volta	Metal
5059	C31	SV ou 1/4 Volta	Metal
5072	C33	SV ou 1/4 Volta	Metal
5098	C38	SV ou 1/4 Volta	Metal
28452	C39	SV ou 1/4 Volta	Metal
5079	C40	SV ou 1/4 Volta	Metal
5104	C50	SV ou 1/4 Volta	Metal
5117	C52	SV ou 1/4 Volta	Metal
26561	C55	1/4 Volta	Metal
16914	C70	1/4 Volta	Metal



3/4 | Mista



Código	Acab.	Variação	Material
5052	C23	SV ou 1/4 Volta	ABS
20538	C31	SV ou 1/4 Volta	ABS
20539	C33	SV ou 1/4 Volta	ABS
20540	C40	SV ou 1/4 Volta	ABS
20542	C50	SV ou 1/4 Volta	ABS



Docol



Código	Acab.	Variação	Material
29146	C40	MVS ou 1/4 Volta	Metal
29148	C42	MVS ou 1/4 Volta	Metal
29147	C50	MVS ou 1/4 Volta	Metal



REGISTRO DE PRESSÃO



1400 / 1403 / 1416 SV
Cód. 6576
Linha 1400 / 1403 /
1416 Universal

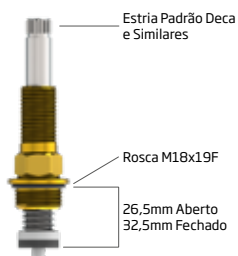

1416 1/2 e 3/4 SV
Cód. 21954
Linha 1416 1/2 e 3/4
Real e Similares



1400 / 1403 / 1416 MVS
Cód. 6579
Linha 1400 / 1403 /
1416 Universal



1416 3/4 LUXO
Cód. 21948
Linha 1416 3/4 Luxo
Real



1416 LUXO
Cód. 29131
Linha 1416 3/4 Luxo
Real

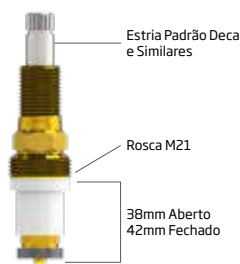

1416 MVS Longo
Cód. 6573
Linha Universal



1416 MVS
Cód. 24614
1416 Deca

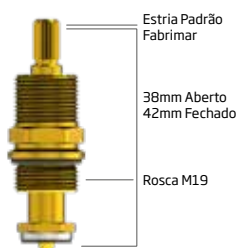

1416 MVS
Cód. 26603
1416 Fabrimar

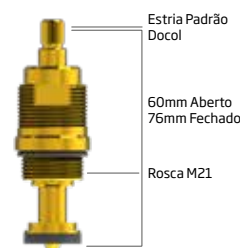

1416 MVS
Cód. 10004
1416 Docol



REPARO SOS
Cód. 28432
Linha 1416 1/2 e 3/4
Real e Similares

TORNEIRA

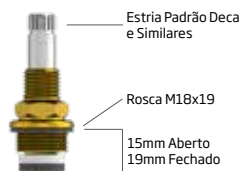

TORNEIRA SV
Cód. 6582
Linha Stander / Universal



TORNEIRA MVS
Cód. 6299
Linha Stander / Universal



TORNEIRA MVS Longo
Cód. 9683
Linha Universal



TORNEIRA MVS Longo
Cód. 5829
Linha 2168



1/4 DE VOLTA M22
Cód. 5919
Linha Classic / Gourmet / ABS

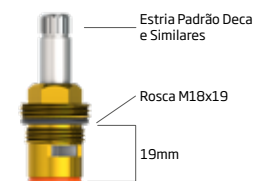

1/4 DE VOLTA M18
Cód. 15686
Linha Stander / Universal

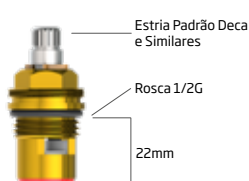

1/4 DE VOLTA M22
Cód. 6570
Linha 1167 / 1168 / 1198 LUXO / 1201
ColorFlex

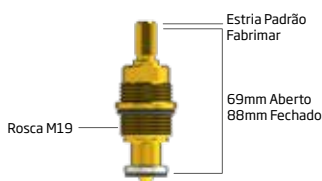

TORNEIRA MVS
Cód. 15437
Fabrimar



VÁLVULA AUTOMÁTICA
Cód. 6585
Linha 1197 / 1197JR / 1197 ABS

CABEÇOTES



Cód. 1703
Standard Amarelo | SV



Cód. 6079
Standard Cromado | SV



Cód. 2403
C23 Cromado | SV



Cód. 2399
C33 Cromado | SV

REPOSIÇÃO



Cód. 30511
PROLONGADOR P/ REGISTRO
DECA - 20MM



Cód. 30512
CONVERSOR REGISTRO
PRESSÃO DECA P/ DOCOL



Cód. 30520
CONVERSOR REGISTRO
PRESSÃO DOCOL P/ DECA



Cód. 30524
CONVERSOR FABRIMAR
P/ DECA



Cód. 30525
ESTRIA PROLONGADORA
P/ DECA CROMADA



Cód. 30528
NIPLE C/ SOBRE
PORCA GIRATÓRIA
NIQUELADO M X F 1/2



Cód. 30529
VÁLVULA COM
REGULADOR DE VAZÃO
P/ TORNEIRA



Cód. 30530
ADAPTADOR
MONOCOMANDO 1/2

BICA



27515



27513



27512



27511



27510



27516



27518



27517



29180

Código	Acab.	Bitola	Material
27515	Color Flex Branco	3/4	Inox/Silicone
27513	Color Flex Laranja	3/4	Inox/Silicone
27512	Color Flex Preto	3/4	Inox/Silicone
27511	Color Flex Vermelho	3/4	Inox/Silicone



Código	Acab.	Bitola	Material
27510	Gourmet	3/4	Inox/ABS
27516	Gourmet Duo	3/4	Inox/ABS
27518	Gourmet Duo Preto	3/4	Inox/Silicone
27517	Gourmet Duo Vermelho	3/4	Inox/Silicone
29180	Luxo	3/4	Inox/Cromada

ACESSÓRIOS

TUBO DE LIGAÇÃO



Código	Acab.	Variação	Material
1059	25cm	Liso	Aluminio Polido
5249	25cm	Ajustável	Aluminio Polido
9303	30cm	Liso	Aluminio Polido
5250	30cm	Ajustável	Aluminio Polido



BRAÇO CHUVEIRO

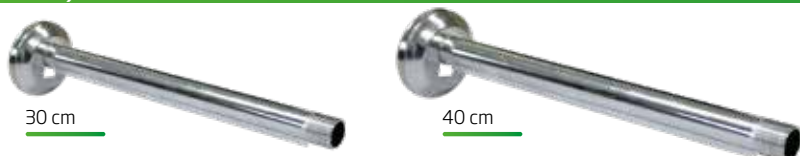

Código	Acab.	Material
8766	30cm	Aluminio Polido
8769	40cm	Aluminio Polido



PROLONGADOR | Bucha



Código	Acab.	Variação	Material
12646	Redução	3/4x1/2	Metal
18030	Reversão	1/2x3/4	Metal



PROLONGADOR | Extensor



Código	Acab.	Variação	Material
14450	4 cm	1/2	Metal
16502	4 cm	3/4	Metal
14447	6 cm	1/2	Metal
16508	6 cm	3/4	Metal



PROLONGADOR | Prolongador



Código	Acab.	Variação	Material
45	4 cm	1/2	Metal
46	4 cm	3/4	Metal
47	6 cm	1/2	Metal
48	6 cm	3/4	Metal
49	8 cm	1/2	Metal
51	8 cm	3/4	Metal
41	4 cm	1/2	Metal Amarelo
8718	4 cm	3/4	Metal Amarelo
8721	6 cm	1/2	Metal Amarelo
8724	6 cm	3/4	Metal Amarelo

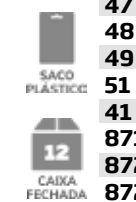

FIXAÇÃO



Código	Acab.	Variação	Material
22267	Fixação Mictório	Incepa/Celite	Aluminio Polido
22268	Fixação Tanque	18 Litros	Latão/Ferro/ABS
22269	Fixação Tanque	22/30 Litros	Latão



ACESSÓRIOS

PARAFUSO

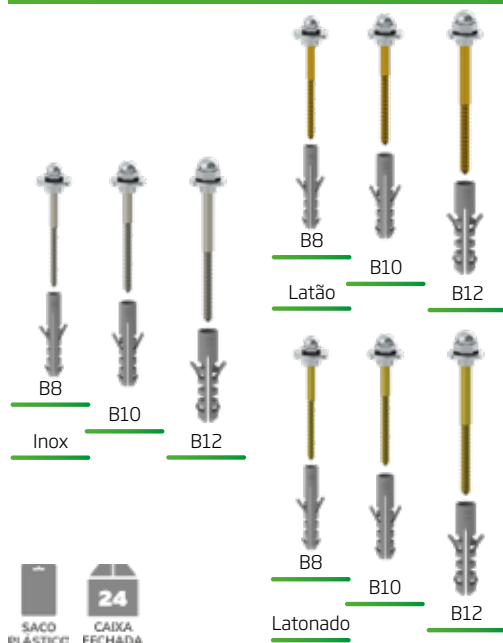

Código	Acab.	Comp.	Variação	Material	Pacote
28046	B08	70mm		Inox	100
28044	B08 C/02 Unidades	70mm	C/02 Unidades	Inox	100
5187	B08	70mm		Latão	100
5929	B08 C/02 Unidades	70mm	C/02 Unidades	Latão	100
5190	B08	70mm		Latonado	100
11048	B08 C/02 Unidades	70mm	C/02 Unidades	Latonado	100
28047	B10	80mm		Inox	100
28043	B10 C/02 Unidades	80mm	C/02 Unidades	Inox	100
5193	B10	80mm		Latão	100
5930	B10 C/02 Unidades	80mm	C/02 Unidades	Latão	100
5196	B10	80mm		Latonado	100
11049	B10 C/02 Unidades	80mm	C/02 Unidades	Latonado	100
28048	B12	95mm		Inox	50
28045	B12 C/02 Unidades	95mm	C/02 Unidades	Inox	50
11178	B12	95mm		Latão	50
11184	B12 C/02 Unidades	95mm	C/02 Unidades	Latão	50
11179	B12	95mm		Latonado	50
14143	B12 C/02 Unidades	95mm	C/02 Unidades	Latonado	50
22476	B10 Especial	100mm		Latão	50
22747	B10 Especial C/02 Unid.	100mm	C/02 Unidades	Latão	50

RALO C/ CAIXILHO | Quadrado / Redondo

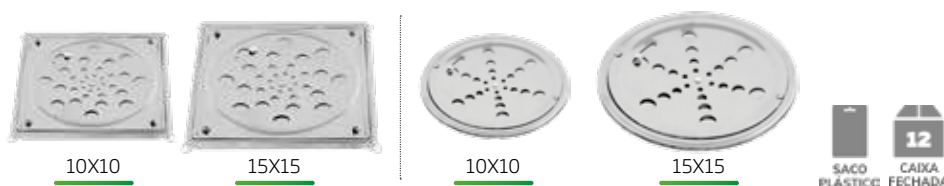

Código	Acab.	Variação	Material
8772	10x10	Quadrado	Inox
8778	15x15	Quadrado	Inox
8775	10x10	Redondo	Inox
8781	15x15	Redondo	Inox

RALO | Pratic



Código	Acab.	Variação	Material
28869	15x10	Box	Inox

GRELHA | Quadrada / Redonda

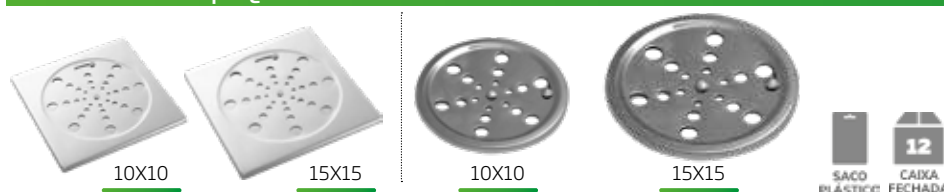

Código	Acab.	Variação	Material
8796	10x10	Quadrado	Inox
8802	15x15	Quadrado	Inox
8799	10x10	Redondo	Inox
8805	15x15	Redondo	Inox

ENGATE | Inox



Código	Acab.	Variação	Material
8949	30 cm	Flexível	Inox
8952	40 cm	Flexível	Inox
8955	60 cm	Flexível	Inox
8943	120 cm	Flexível	Inox
8946	180 cm	Flexível	Inox

ENGATE | Trançado



Código	Acab.	Variação	Material
8958	30 cm	Flexível	Inox Trançado
8961	40 cm	Flexível	Inox Trançado
8964	60 cm	Flexível	Inox Trançado

ACESSÓRIOS

VÁLVULA



Código	Acab.	Variação	Bitola	Material
4806	1600		7/8	Metal
4815	1603	C/Ladrão	7/8	Metal
20488	1603	C/Ladrão e Porca Metal	7/8	Metal
4818	1603		7/8	Metal
20489	1603	Porca Metal	7/8	Metal
4822	1605		1.1/4	Metal
4825	1623		3.1/2	Metal
20452	1623	Porca Metal	3.1/2	Metal



Click 1.1/4



Código	Acab.	Variação	Bitola	Material
24912	1605	Click	1.1/4	Inox/ABS

BÓIA



Júnior 1/2

Júnior 3/4



Código	Acab.	Variação	Abertura	Material
4536	Junior	1/2	Reduzida	Metal/Boia PVC
4539	Junior	3/4	Reduzida	Metal/Boia PVC
4551	Vazão Total	1	Total	Metal/Boia PVC
4554	Vazão Total	1.1/2	Total	Metal/Boia PVC
4557	Vazão Total	1/2	Total	Metal/Boia PVC
4561	Vazão Total	3/4	Total	Metal/Boia PVC

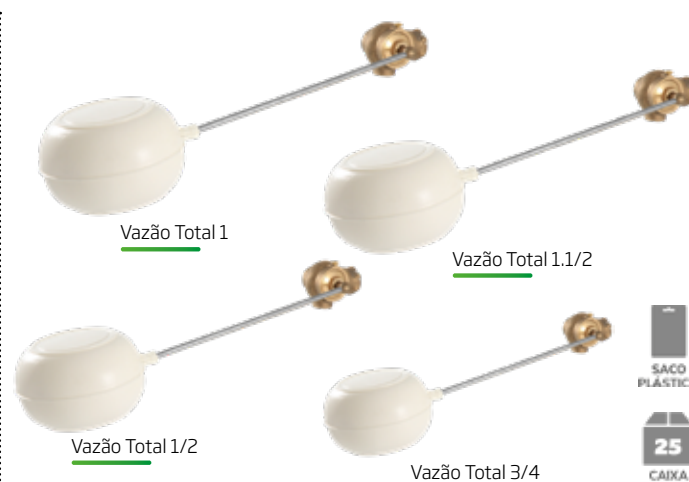

Vazão Total 1

Vazão Total 1.1/2

Vazão Total 1/2

Vazão Total 3/4



ELÉTRICO | Grampo



Código	Acab.	Variação	Material
11063	Grampo	Aterramento	Latão



ELÉTRICO | Conector



Código	Acab.	Variação	Material
13576	Conector	Haste Aterramento	Latão



ELÉTRICO | Terminal de Bateria

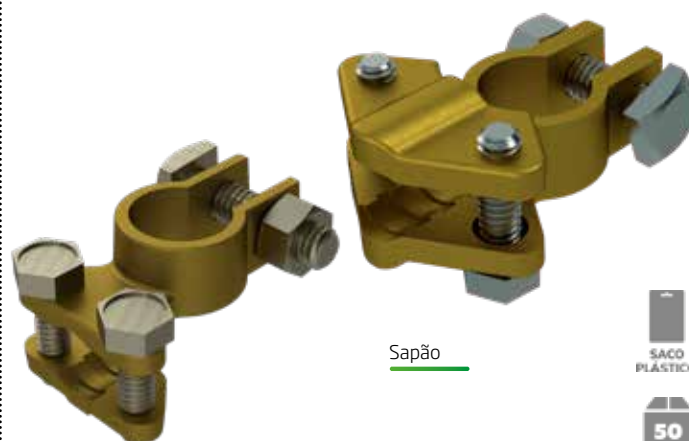

Sapão

Sapinho



Código	Acab.	Variação	Material
17878	Terminal de Bateria	Sapão c/Parafuso	Latão
16729	Terminal de Bateria	Sapão s/Parafuso	Latão
17879	Terminal de Bateria	Sapinho c/Parafuso	Latão
17860	Terminal de Bateria	Sapinho s/Parafuso	Latão

ACESSÓRIOS

PUXADOR | Redondo

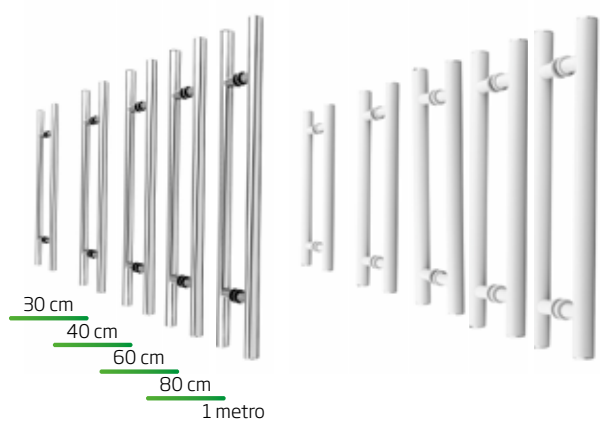

Código	Acab.	Variação	Material
27321	30	Redondo	Aluminio Polido
27351	40	Redondo	Aluminio Polido
27352	60	Redondo	Aluminio Polido
27353	80	Redondo	Aluminio Polido
27856	1	Redondo	Aluminio Polido
27818	30	Redondo	Aluminio Branco
27819	40	Redondo	Aluminio Branco
27820	60	Redondo	Aluminio Branco
27821	80	Redondo	Aluminio Branco
27857	1	Redondo	Aluminio Branco
27826	30	Redondo	Aluminio Preto
27827	40	Redondo	Aluminio Preto
27828	60	Redondo	Aluminio Preto
27829	80	Redondo	Aluminio Preto
27858	1	Redondo	Aluminio Preto

PUXADOR | REDONDO ORIENTE

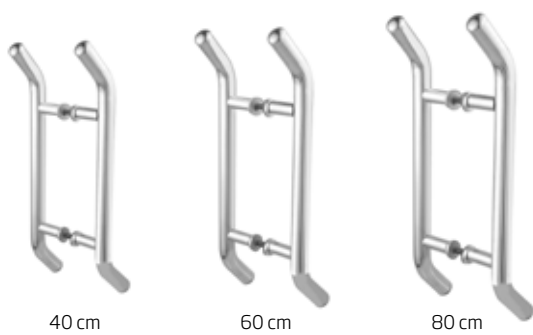

Código	Acab.	Variação	Material
28882	40 Oriente	Redondo	Aluminio Polido
28883	60 Oriente	Redondo	Aluminio Polido
28884	80 Oriente	Redondo	Aluminio Polido

PUXADOR | BARRA CHATA

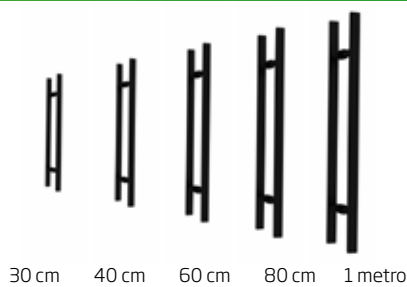

Código	Acab.	Variação	Material
27323	30	Chata	Aluminio Polido
27354	40	Chata	Aluminio Polido
27355	60	Chata	Aluminio Polido
27356	80	Chata	Aluminio Polido
27853	1	Chata	Aluminio Polido
27324	30	Chata	Aluminio Branco
27325	40	Chata	Aluminio Branco
27326	60	Chata	Aluminio Branco
27327	80	Chata	Aluminio Branco
27854	1	Chata	Aluminio Branco
27822	30	Chata	Aluminio Preto
27823	40	Chata	Aluminio Preto
27824	60	Chata	Aluminio Preto
27825	80	Chata	Aluminio Preto
27855	1	Chata	Aluminio Preto

PUXADOR | BARRA CHATA SLIM

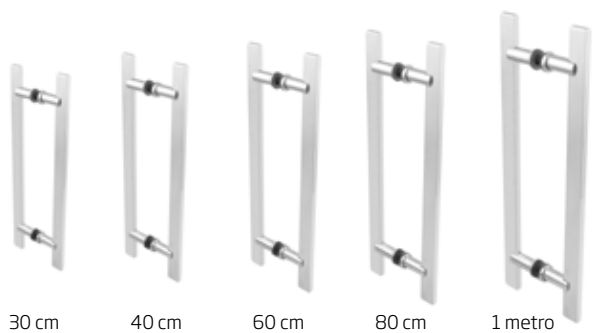

Código	Acab.	Variação	Material
28870	30 Slim	Chata	Aluminio Polido
28871	40 Slim	Chata	Aluminio Polido
28872	60 Slim	Chata	Aluminio Polido
28873	80 Slim	Chata	Aluminio Polido
28874	1 Slim	Chata	Aluminio Polido

BARRA DE APOIO | Reta

POLIDO

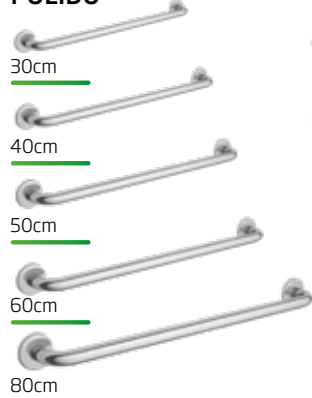

BRANCO



PRETO



Código	Acab.	Bitola	Material
5775	30	1.1/4	Aluminio Polido
5776	40	1.1/4	Aluminio Polido
5777	50	1.1/4	Aluminio Polido
5778	60	1.1/4	Aluminio Polido
5779	80	1.1/4	Aluminio Polido
27956	30	1.1/4	Aluminio Branco
27958	40	1.1/4	Aluminio Branco
27960	50	1.1/4	Aluminio Branco
27962	60	1.1/4	Aluminio Branco
27964	80	1.1/4	Aluminio Branco
27957	30	1.1/4	Aluminio Preto
27959	40	1.1/4	Aluminio Preto
27961	50	1.1/4	Aluminio Preto
27963	60	1.1/4	Aluminio Preto
27965	80	1.1/4	Aluminio Preto



BARRA DE APOIO | Especial



em "L" Parede

Canto



Articulada 60

Articulada 80

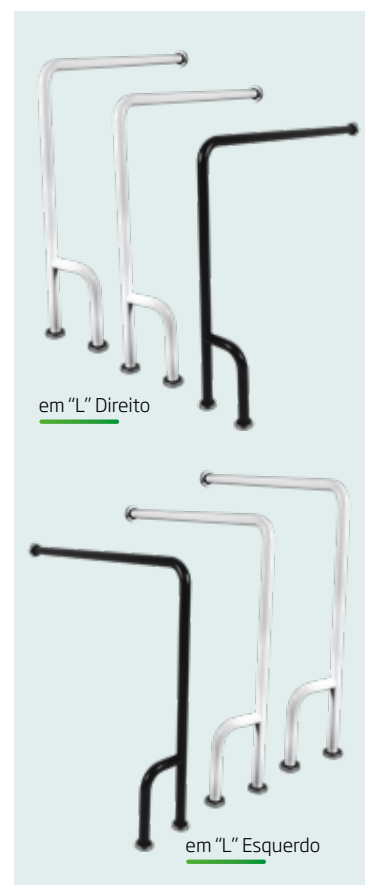

em "L" Direito

em "L" Esquerdo

Código	Acab.	Varição	Bitola	Material
27387	60	Articulada	1.1/4	Aluminio Polido
28410	60	Articulada	1.1/4	Aluminio Branco
28411	60	Articulada	1.1/4	Aluminio Preto
27388	80	Articulada	1.1/4	Aluminio Polido
28412	80	Articulada	1.1/4	Aluminio Branco
28413	80	Articulada	1.1/4	Aluminio Preto
27391	60	L	1.1/4	Aluminio Polido
28424	60	L	1.1/4	Aluminio Branco
28425	60	L	1.1/4	Aluminio Preto
27383	70	L	1.1/4	Aluminio Polido
28416	70	L	1.1/4	Aluminio Branco
28417	70	L	1.1/4	Aluminio Preto
27384	70X80	L	1.1/4	Aluminio Polido
28418	70X80	L	1.1/4	Aluminio Branco
28419	70X80	L	1.1/4	Aluminio Preto
27385	80X70	L Direita	1.1/4	Aluminio Polido
28420	80X70	L Direita	1.1/4	Aluminio Branco
28421	80X70	L Direita	1.1/4	Aluminio Preto
27386	80X70	L Esquerda	1.1/4	Aluminio Polido
28422	80X70	L Esquerda	1.1/4	Aluminio Branco
28423	80X70	L Esquerda	1.1/4	Aluminio Preto
27390	40X50	Lavatório	1.1/4	Aluminio Polido
28426	40X50	Lavatório	1.1/4	Aluminio Branco
28427	40X50	Lavatório	1.1/4	Aluminio Preto
27392	Canto	Pés	1.1/4	Aluminio Polido
28414	Canto	Pés	1.1/4	Aluminio Branco
28415	Canto	Pés	1.1/4	Aluminio Preto



em "L" 70x80



Lavatório

KIT PARA BANHEIRO

STANDARD LUXO | Cromado



Código 20935 **Acabamento** Kit Standard Luxo **Material** Alumínio/Inox

5 PEÇAS ACRÍLICO | Transparente



Código 17740 **Acabamento** Kit 5 Peças Acrílico **Material** Alumínio/ABS/Acrílico Transparente

STANDARD | Cromado



Código 9246 **Acabamento** Kit Standard **Material** Alumínio/Inox

5 PEÇAS ACRÍLICO | Fumê



Código 17739 **Acabamento** Kit 5 Peças Acrílico **Material** Alumínio/ABS/Acrílico Fumê

* Peças vendida avulsa (separadamente).

JUNIOR | Cromado



Código 5260 **Acabamento** Kit Junior **Material** Alumínio/Inox

5 PEÇAS ACRÍLICO | Verde



Código 17753 **Acabamento** Kit 5 Peças Acrílico **Material** Alumínio/ABS/Acrílico Verde

* Peça vendida avulsa (separadamente).

KIT PARA BANHEIRO

CLEAN

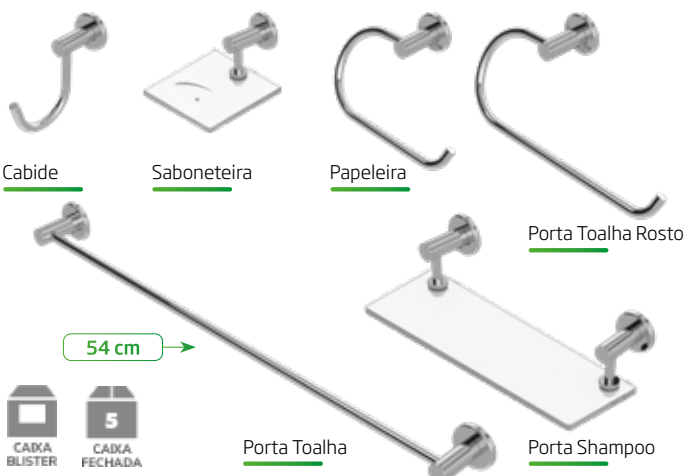

Cabide

Saboneteira

Papeleira

Porta Toalha Rosto

54 cm

Porta Toalha

Porta Shampoo



Código 5282 **Acabamento** Kit 6 Peças Clean **Material** Alumínio/Inox/Vidro



ACESSÓRIOS PARA BANHEIRO | PORTA SHAMPOO



Canto

Canto Duplo

Reto

Reto Duplo

Reto Luxo

em "L"

	Código	Acab.	Variação	Material
SACO PLÁSTICO	5124	Canto	21cm x 21cm / 6mm	Alumínio/Vidro
	26499	Canto Duplo	21cm x 21cm / 6mm	Alumínio/Vidro
CAIXA FECHADA 6	9291	Reto	10cm x 30cm / 6mm	Alumínio/Vidro
	26500	Reto Duplo	10cm x 30cm / 6mm	Alumínio/Vidro
	11829	Reto Luxo	13cm x 40cm / 8mm	Alumínio/Vidro
	5130	L	Meia Lua 6mm	Alumínio/Vidro

ACESSÓRIOS PARA BANHEIRO | CHUVEIRO



1992

1993

Código	Acab.	Variação	Material
13356	1992	10X10 Redonda	ABS
13353	1993	10x10 Quadrada	ABS

Reposição			
21364	1995	Desviador e Engate 1,80m	Metal/Inox
20766	1995	Desviador	Metal



20766

21364



Torneira Jato Escolar 1010

Base para Parede

Código	Acab.	Abertura	Material
24727	Jato Escolar	Automatico	Metal



Torneira 1110

Base para Parede

Código	Acab.	Abertura	Material
24653	C33	1/4 Volta	Metal
24654	C40	1/4 Volta	Metal



Torneira 2029

Base para Parede

Código	Acab.	Abertura	Material
24729	C25	1/4 Volta	Metal
24658	C25 c/ Canopla	1/4 Volta	Metal
24660	C33	1/4 Volta	Metal



Torneira 2090

Base para Bancada

Código	Acab.	Abertura	Material
24748	C31 Faucet 0030	1/4 Volta	Metal
24733	C31 Faucet 0031	1/4 Volta	Metal



Base Torneira 2170

Base para Parede

Código	Acab.	Abertura	Material
24889	C40 3/8	1/4 Volta	Metal
24896	C40 Bico Rio M (6,5mm)	1/4 Volta	Metal

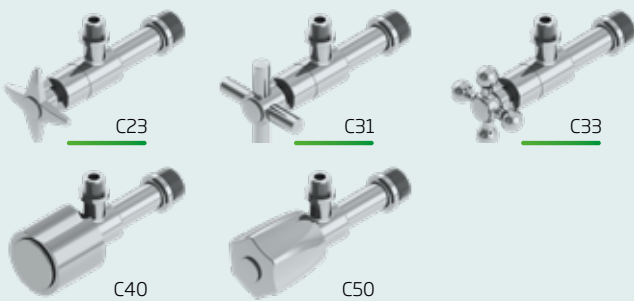

Adaptador para Filtro 1147

Base para Parede

Código	Acab.	Variação	Material
8817	C23	MVS	Metal
28377	C31	MVS	Metal
8823	C33	MVS	Metal
8832	C40	MVS	Metal
8838	C50	MVS	Metal



Adaptador para Filtro 1148

Base para Parede

Código	Acab.	Variação	Material
8856	C23	MVS	Metal
8886	C31	MVS	Metal
8862	C33	MVS	Metal
8871	C40	MVS	Metal
8877	C50	MVS	Metal





Adaptador 1014

Base para Parede

Código	Acab.	Material
24695	Bucha T 3/4 M (6,5mm)	Metal



Adaptador 1015

Base para Parede

Código	Acab.	Material
25162	Bucha T 1/2 P (5,5mm)	Metal
24651	Bucha T 1/2 M (6,5mm)	Metal
24806	Bucha T 1/2 G (8,5mm)	Metal



Adaptador 1015 c/ Regulador

Base para Parede

Código	Acab.	Material
25163	Bucha T 1/2 c/ Reg P (5,5mm)	Metal
24698	Bucha T 1/2 c/ Reg M (6,5mm)	Metal
24949	Bucha T 1/2 c/ Reg G (8,5mm)	Metal



Adaptador 3012

Base para Parede

Código	Acab.	Material
25066	Adaptador C25 Y 1/2 P (5,5mm)	Metal
24890	Adaptador C25 Y 1/2 M (6,5mm)	Metal
25726	Adaptador C25 Y 1/2 G (8,5mm)	Metal
26101	Adaptador C40 Y 1/2 P (5,5mm)	Metal
24663	Adaptador C40 Y 1/2 M (6,5mm)	Metal
25160	Adaptador C40 Y 1/2 G (8,5mm)	Metal



3016

Base para Parede

Código	Acab.	Material
25164	Adaptador P (5,5mm)	Metal
24710	Adaptador M (6,5mm)	Metal
24805	Adaptador G (8,5mm)	Metal



Adaptador 3016 c/ Regulador

Base para Parede

Código	Acab.	Material
24665	Adaptador c/ Reg P (5,5mm)	Metal
24711	Adaptador c/ Reg M (6,5mm)	Metal
25442	Adaptador c/ Reg G (8,5mm)	Metal



Adaptador 4013

Base para Parede

Código	Acab.	Material
24667	Adaptador Y 3/4 c/Canopla M (6,5mm)	Metal

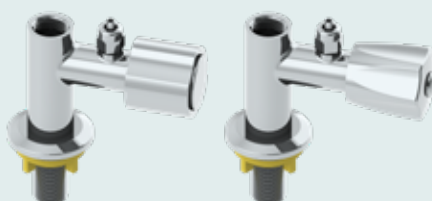

Adaptador 4014

Base para Bancada

Código	Acab.	Material
25623	Adaptador C25 M (6,5mm)	Metal
24720	Adaptador C40 M (6,5mm)	Metal



Adaptador 1016 Caps

Base para Parede

Código	Acab.	Material
25859	Adaptador c/ Bico P (5,5mm)	Metal
24700	Adaptador c/ Bico M (6,5mm)	Metal
25860	Adaptador c/ Bico G (8,5mm)	Metal



Tampão 1/2

Base para Parede

Código	Acab.	Material
24688	Tampão 1/2	Metal

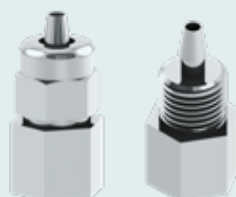

Bico Rio

Base para Parede

Código	Acab.	Material
24766	Bico Rio PP (5mm)	Metal
24644	Bico Rio P (5,5mm)	Metal
24643	Bico Rio M (6,5mm)	Metal
24758	Bico Rio G (8,5mm)	Metal

REPOSIÇÃO REPARO LINHA BEBEDOURO



TABELA ESPIGÕES LINHA BEBEDOURO

TAM.	MANGUEIRA MEDIDA	ESPIGÃO MEDIDA	PORCA
PP	1/4" (6,35mm)	5,0mm	6,5mm
P	1/4" (6,35mm)	5,5mm	6,5mm
M	5/16" (8,0mm)	6,5mm (7,0mm)	8,0mm
G	3/8" (9,5mm)	8,5mm	10,0mm

Lavabo BARCELONA 50



Código	Lavabo	Variação	Cor	Material
28019	Barcelona	50 cm	Branco	MDF
28020	Barcelona	50 cm	Fresno Negro	MDF
28021	Barcelona	50 cm	Griggio	MDF
28022	Barcelona	50 cm	Western	MDF
28023	Combo Barcelona	50 cm (Torneira 2030 + Valvula Click)	Branco	MDF
28024	Combo Barcelona	50 cm (Torneira 2030 + Valvula Click)	Fresno Negro	MDF
28025	Combo Barcelona	50 cm (Torneira 2030 + Valvula Click)	Griggio	MDF
28026	Combo Barcelona	50 cm (Torneira 2030 + Valvula Click)	Western	MDF

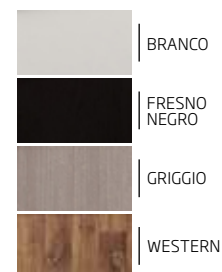

Lavabo BARCELONA 80



Código	Lavabo	Variação	Cor	Material
28027	Barcelona	80 cm	Branco	MDF
28028	Barcelona	80 cm	Fresno Negro	MDF
28029	Barcelona	80 cm	Griggio	MDF
28030	Barcelona	80 cm	Western	MDF
28031	Combo Barcelona	80 cm (Torneira 2030 + Valvula Click)	Branco	MDF
28032	Combo Barcelona	80 cm (Torneira 2030 + Valvula Click)	Fresno Negro	MDF
28033	Combo Barcelona	80 cm (Torneira 2030 + Valvula Click)	Griggio	MDF
28034	Combo Barcelona	80 cm (Torneira 2030 + Valvula Click)	Western	MDF

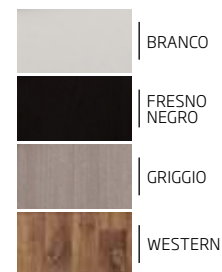

Lavabo BARI 45

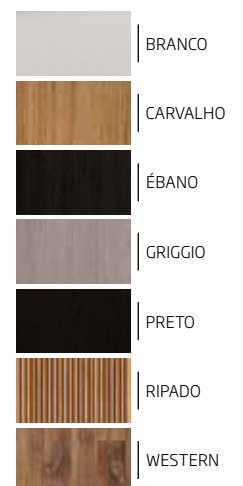

Código	Lavabo	Varição	Cor	Material
101585	Bari 4504	45 cm	Branco	MDF
102879	Bari 4504	45 cm	Branco c/ Carvalho	MDF
102880	Bari 4504	45 cm	Branco c/ Ébano	MDF
103117	Bari 4504	45 cm	Branco c/ Griggio	MDF
101587	Bari 4504	45 cm	Branco c/ Preto	MDF
101592	Bari 4504	45 cm	Branco c/ Ripado	MDF
101589	Bari 4504	45 cm	Branco c/ Western	MDF

Lavabo MADRI 50



Código	Lavabo	Variação	Cor	Material
20720	Madri	50 cm	Branco	MDF
20829	Madri	50 cm	Fresno Negro	MDF
20827	Madri	50 cm	Griggio	MDF
20828	Madri	50 cm	Western	MDF
27225	Combo Madri	50 cm (Torneira 2040 + Valvula Click)	Branco	MDF
27226	Combo Madri	50 cm (Torneira 2040 + Valvula Click)	Fresno Negro	MDF
27227	Combo Madri	50 cm (Torneira 2040 + Valvula Click)	Griggio	MDF
27228	Combo Madri	50 cm (Torneira 2040 + Valvula Click)	Western	MDF

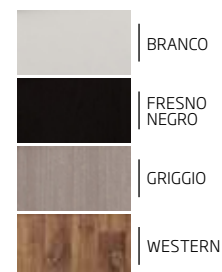

Lavabo MADRI 80



Código	Lavabo	Variação	Cor	Material
20721	Madri	80 cm	Branco	MDF
20834	Madri	80 cm	Fresno Negro	MDF
20832	Madri	80 cm	Griggio	MDF
20833	Madri	80 cm	Western	MDF
27331	Combo Madri	80 cm (Torneira 2040 + Valvula Click)	Branco	MDF
27332	Combo Madri	80 cm (Torneira 2040 + Valvula Click)	Fresno Negro	MDF
27333	Combo Madri	80 cm (Torneira 2040 + Valvula Click)	Griggio	MDF
27334	Combo Madri	80 cm (Torneira 2040 + Valvula Click)	Western	MDF

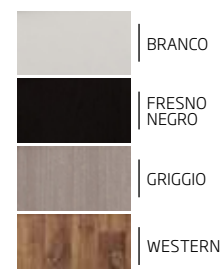

Lavabo MARANATA 60



Código	Lavabo	Variação	Cor	Material
28035	Maranata	60 cm	Branco	MDF
28037	Maranata	60 cm	Fresno Negro	MDF
28036	Maranata	60 cm	Griggio	MDF
28038	Maranata	60 cm	Western	MDF
28123	Combo Maranata	60 cm (Torneira 2040 + Valvula Click)	Branco	MDF
28122	Combo Maranata	60 cm (Torneira 2040 + Valvula Click)	Fresno Negro	MDF
28121	Combo Maranata	60 cm (Torneira 2040 + Valvula Click)	Griggio	MDF
28120	Combo Maranata	60 cm (Torneira 2040 + Valvula Click)	Western	MDF

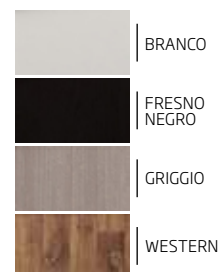

Lavabo MARANATA 80



Código	Lavabo	Variação	Cor	Material
27711	Maranata	80 cm	Branco	MDF
27712	Maranata	80 cm	Fresno Negro	MDF
27713	Maranata	80 cm	Griggio	MDF
27714	Maranata	80 cm	Western	MDF
28118	Combo Maranata	80 cm (Torneira 2040 + Valvula Click)	Branco	MDF
28117	Combo Maranata	80 cm (Torneira 2040 + Valvula Click)	Fresno Negro	MDF
28116	Combo Maranata	80 cm (Torneira 2040 + Valvula Click)	Griggio	MDF
28115	Combo Maranata	80 cm (Torneira 2040 + Valvula Click)	Western	MDF

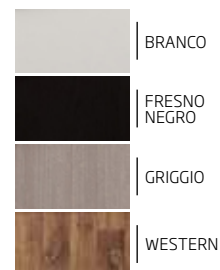

Lavabo REAL 60



Código	Lavabo	Variação	Cor	Material
28463	Real	60 cm	Branco	MDF
28464	Real	60 cm	Fresno Negro	MDF
28465	Real	60 cm	Griggio	MDF
28466	Real	60 cm	Western	MDF
28435	Combo Real	60 cm (Torneira 2030 + Valvula Click)	Branco	MDF
28434	Combo Real	60 cm (Torneira 2030 + Valvula Click)	Fresno Negro	MDF
28433	Combo Real	60 cm (Torneira 2030 + Valvula Click)	Griggio	MDF
28153	Combo Real	60 cm (Torneira 2030 + Valvula Click)	Western	MDF

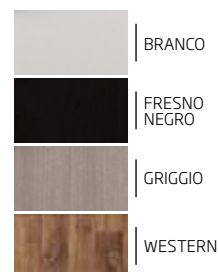

Lavabo REAL 80



Código	Lavabo	Variação	Cor	Material
28467	Real	80 cm	Branco	MDF
28468	Real	80 cm	Fresno Negro	MDF
28469	Real	80 cm	Griggio	MDF
28470	Real	80 cm	Western	MDF
28152	Combo Real	80 cm (Torneira 2030 + Valvula Click)	Branco	MDF
28151	Combo Real	80 cm (Torneira 2030 + Valvula Click)	Fresno Negro	MDF
28150	Combo Real	80 cm (Torneira 2030 + Valvula Click)	Griggio	MDF
28149	Combo Real	80 cm (Torneira 2030 + Valvula Click)	Western	MDF

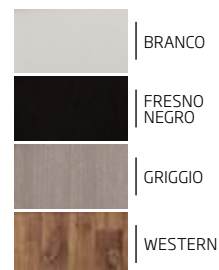

Lavabo FULL 50 | 80

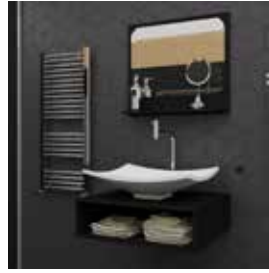

Código	Lavabo	Variação	Cor	Material
28829	Full	50 cm	Branco	MDF
28831	Full	50 cm	Black	MDF
28849	Combo Full	50 cm (Torneira 2040 + Valvula Click)	Branco	MDF
28848	Combo Full	50 cm (Torneira 2040 + Valvula Click)	Black	MDF
28834	Full	80 cm	Branco	MDF
28836	Full	80 cm	Black	MDF
28851	Combo Full	80 cm (Torneira 2040 + Valvula Click)	Branco	MDF
28850	Combo Full	80 cm (Torneira 2040 + Valvula Click)	Black	MDF

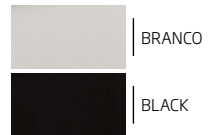

Lavabo FULL EDITION 50 | 80



Código	Lavabo	Variação	Cor	Material
28853	Full Edition	50 cm	Branco	MDF
28852	Full Edition	50 cm	Black	MDF
28861	Combo Full Edition	50 cm (Torneira 2040 + Valvula Click)	Branco	MDF
28860	Combo Full Edition	50 cm (Torneira 2040 + Valvula Click)	Black	MDF
28855	Full Edition	80 cm	Branco	MDF
28854	Full Edition	80 cm	Black	MDF
28863	Combo Full Edition	80 cm (Torneira 2040 + Valvula Click)	Branco	MDF
28862	Combo Full Edition	80 cm (Torneira 2040 + Valvula Click)	Black	MDF

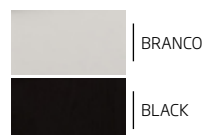

EXPOSITOR

CÓD. 5562

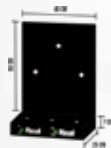

BALCÃO LOJA

3 TORNEIRAS PAREDE
3 TORNEIRAS MESA

CÓD. 26578



CENTRO DE LOJA ARAMADO

20 GANCHOS 18CM CADA
7 TORNEIRAS PAREDE
7 TORNEIRAS MESA

CÓD. 24127



AMBIENTE GRANDE

7 TORNEIRAS PAREDE
7 TORNEIRAS MESA

CÓD. 26524



CANALETADO GRANDE

30 GANCHOS 18CM CADA

1 | CÓD. 24127
2 | CÓD. 26524



CONJUNTO MISTO CANALETADO GRANDE

1 - 7 TORNEIRAS PAREDE
7 TORNEIRAS MESA
2 - 30 GANCHOS 18CM CADA

CÓD. 27883



GÔNDOLA MISTO

25 GANCHOS P/ CANALETADO
32 GANCHOS P/ ARAMADO

CÓD. 27887



MADEIRA FRENTE

7 TORNEIRAS PAREDE
7 TORNEIRAS MESA

CÓD. 20467



MADEIRA FRENTE E VERSO

14 TORNEIRAS PAREDE
14 TORNEIRAS MESA

CÓD. 5561



ARAMADO PEQUENO

20 GANCHOS 18CM CADA
1 CESTO

CÓD. 18766

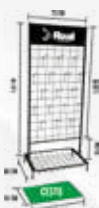
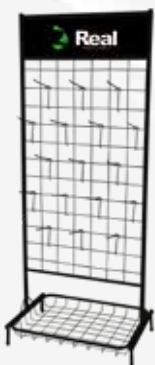

ARAMADO MÉDIO

24 GANCHOS 18CM CADA
1 CESTO

CÓD. 18768

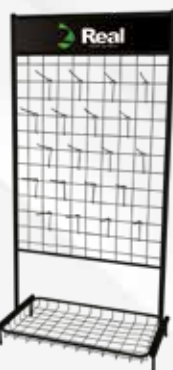

ARAMADO GRANDE

32 GANCHOS 18CM CADA
1 CESTO



MISSÃO

Ser reconhecida como uma empresa pioneira em inovação, satisfazendo nossos clientes através da diversidade de produtos de qualidade.

VISÃO

Ser reconhecida como uma das melhores empresas de metais sanitários do Brasil.

VALORES

Todo nosso trabalho está pautado nos VALORES da integração com Stakeholders, ética, sustentabilidade, pioneirismo, inovação e comunicação.

PROPÓSITO

Promover a integridade colaborativa entre todos nossos colaboradores, parceiros e clientes.

PROPOSTA DE VALOR

Com a linha completa de torneiras e acabamentos em metal e ABS, a reforma e construção da casa dos seus sonhos, agora, é **REAL!**

